

WIFO

1030 WIEN, ARSENAL, OBJEKT 20
TEL. 798 26 01 • FAX 798 93 86

 **ÖSTERREICHISCHES INSTITUT FÜR
WIRTSCHAFTSFORSCHUNG**



Labour Market Monitor 2012

**A Europe-wide Labour Market Monitoring
System Updated Annually**

Silvia Haas, Ulrike Huemer, Helmut Mahringer

October 2013

Labour Market Monitor 2012

A Europe-wide Labour Market Monitoring System Updated Annually

Silvia Haas, Ulrike Huemer, Helmut Mahringer

October 2013

Austrian Institute of Economic Research
Commissioned by Chamber of Labour: Vienna
Internal review: Hedwig Lutz

Abstract

The report is an update of a set of labour market indices, which has been developed in 2010 in collaboration with a team of experts from the Vienna Chamber of Labour (AK). It allows for a Europe-wide comparison of labour market developments in the following five key dimensions: overall labour market performance (area index 1), orientation towards integration (area index 2), equity and continuity (area index 3), distribution of earnings (area index 4) and distribution through the welfare state (area index 5). The calculation of the area indices is primarily based on data from 2011 and 2010. The report summarises the current results of the five area indices and contains a cartographic overview.

Please refer to: Silvia.Haas@wifo.ac.at, Ulrike.Huemer@wifo.ac.at, Helmut.Mahringer@wifo.ac.at

2013/403/S/WIFO project no: 6312

© 2013 Austrian Institute of Economic Research

Medieninhaber (Verleger), Herausgeber und Hersteller: Österreichisches Institut für Wirtschaftsforschung,
1030 Wien, Arsenal, Objekt 20 • Tel. (+43 1) 798 26 01-0 • Fax (+43 1) 798 93 86 • <http://www.wifo.ac.at/> • Verlags- und Herstellungsort: Wien

Verkaufspreis: 50,00 € • Kostenloser Download: <http://www.wifo.ac.at/wwa/pubid/46992>

Table of contents

List of figures	3
List of tables	4
Abbreviations	6
1. Introduction	7
2. Five indices to monitor the labour market	10
2.1 <i>Five dimensions of the Labour Market Monitor</i>	10
2.2 <i>The indicators behind the Labour Market Monitor</i>	11
3. Data sources and methodology	15
3.1 <i>Sources of indicators</i>	15
3.2 <i>Reference period for the data analysed</i>	16
3.3 <i>Missing values</i>	17
3.4 <i>Modification of individual indicators</i>	17
3.5 <i>Index methodology</i>	17
3.6 <i>Country categorization</i>	19
4. Key findings	20
4.1 <i>Overview of key findings for Austria</i>	20
4.2 <i>Key findings by area index</i>	22
4.2.1 <i>Area index 1 – Overall Labour Market Performance</i>	22
4.2.2 <i>Area index 2 – Orientation towards Integration</i>	26
4.2.3 <i>Area index 3 – Equity of Access and Continuity</i>	29
4.2.4 <i>Area index 4 – Distribution of Earnings</i>	33
4.2.5 <i>Area index 5 – Distribution by the Welfare State</i>	37
4.3 <i>Alternative representation of key findings by area index</i>	40
5. Summary	46
References	47
Appendix A – Significant results and calculation steps	48
Appendix B – Definitions, sources and data availability	54
B.1 <i>Definitions</i>	54
B.1.1 <i>Overall Labour Market Performance (1) and Orientation towards Integration (2)</i>	54
B.1.2 <i>Equity of Access and Continuity (3)</i>	58
B.1.3 <i>Distribution of Earnings (4)</i>	62
B.1.4 <i>Distribution by the Welfare State (5)</i>	64
B.2 <i>Used data sources</i>	66
B.3 <i>Data availability</i>	71

Appendix C – Sensitivity Analysis	78
Appendix Tables	86

List of figures

Figure 1:	Overview of the Labour Market Monitor Model: area indices and sub-areas	8
Figure 2:	Overview of the five dimensions of the Labour Market Monitor	10
Figure 3:	Overview of the data sources used in each area indices	15
Figure 4:	Overview of the results of the area indices	21
Figure 5:	Area index 1 – Overall labour market performance	23
Figure 6:	Area index 2 – Orientation towards Integration (excl. LU and MT)	27
Figure 7:	Area index 3 – Equity of access and continuity (excl. BG and EE)	31
Figure 8:	Area index 4 – Distribution of Earnings	35
Figure 9:	Area index 5 – Distribution by the Welfare State	38
Figure 10:	Index calculation 2012 – Country groupings by area index with minimum distance of 0.7 points	43
Figure 11:	Index calculation 2012 – Country groupings by area index with minimum distance of 0.6 points	44
Figure 12:	Index calculation 2011 – Country groupings by area index on basis of revised data	45

List of tables

Table 1:	Area index 1 – sub-areas and indicators	11
Table 2:	Area index 2 – sub-areas and indicators	12
Table 3:	Area index 3 – sub-areas and indicators	13
Table 4:	Area index 4 – sub-areas and indicators	13
Table 5:	Area index 5 – sub-areas and indicators	14
Table 6:	Distribution of the point values of the area indices	20
Table 7:	Country categorization – Overall Labour Market Performance (Area index 1)	24
Table 8:	Country categorization – Orientation towards Integration (Area index 2)	28
Table 9:	Country categorization – Equity of Access and Continuity (Area index 3)	32
Table 10:	Country categorization – Distribution of Earnings (Area index 4)	36
Table 11:	Country categorization – Distribution by the Welfare State (Area index 5)	40
Table 12:	List of indicators	48
Table 13:	Indicators and weights	50
Table 14:	Point value and range of the five area indices (unsorted)	52
Table 15:	Point value and ranking of the five area indices (sorted according to rank)	53
Table 16:	Data availability for the indicators of area index 1: Overall Labour Market Performance	71
Table 17:	Data availability for the indicators of area index 2: Orientation towards Integration	72
Table 18:	Data availability for the indicators of area index 3: Equity of Access and Continuity	74
Table 19:	Data availability for the indicators of area index 4: Distribution of Earnings	76
Table 20:	Data availability for the indicators of area index 5: Distribution by the Welfare State	77
Table 21:	Overview of all analyses applied	78
Table 22:	Overall Labour Market Performance (1) – change in ranking position for Austria	80
Table 23:	Orientation towards Integration (2) – change in ranking position for Austria	80
Table 24:	Equity of Access and Continuity (3) – change in ranking position for Austria	81
Table 25:	Distribution of Earnings (4) – change in ranking position for Austria	82
Table 26:	Distribution by the Welfare State (5) – change in ranking position for Austria	83
Table 27:	Distribution by the Welfare State (5) – Extended sensitivity analysis	84
Table 28:	Ranking position of all five area indices according to the calculation variations ¹⁾	85
Table 29:	Raw data of the individual indicators of area index 1 – Overall Labour Market Performance, EU-27	87
Table 30:	Ranking position of area index 1 – Overall Labour Market Performance, EU-27	88

Table 31: Raw data of the individual indicators of area index 2 – Orientation towards Integration, EU-27	89
Table 32: Ranking positioning of area index 2 - Orientation towards Integration, EU-27 (excl. LU and MT)	91
Table 33: Raw data of individual indicators of the area index 3 - Equity of Access and Continuity, EU-27 (excl. BG and EE)	93
Table 34: Ranking position of the area index 3 – Equity of Access and Continuity, EU-27 (excl. BG and EE)	96
Table 35: Raw data of the individual indicators of area index 4 – Distribution of Earnings, EU-27	98
Table 36: Ranking position of area index 4 – Distribution of Earnings, EU-27	99
Table 37: Raw data of the individual indicators of area index 5 - Distribution by the Welfare State, EU-27	100
Table 38: Ranking position of the area index 5 - Distribution welfare state, EU-27	101

Abbreviations

EU-27: The 27 member states of the European Union (since 1.1.2007):

BE	Belgium
BG	Bulgaria
CZ	Czech Republic
DK	Denmark
DE	Germany
EE	Estonia
IE	Ireland
GR/EL	Greece
ES	Spain
FR	France
IT	Italy
CY	Cyprus
LV	Latvia
LT	Lithuania
LU	Luxembourg
HU	Hungary
MT	Malta
NL	Netherlands
AT	Austria
PL	Poland
PT	Portugal
RO	Romania
SI	Slovenia
SK	Slovakia
FI	Finland
SE	Sweden
UK	United Kingdom

LMP	Labour market policy
GDP	Gross domestic product
PPS	Purchasing Power Standard
NAS	National Account Systems

Sources

CVTS	Continuing Vocational Training Survey (European survey on vocational training)
DG TAX DU	The Directorate-General for Taxation and Customs Union – Taxation Trends in the European Union
EU-LFS	EU Labour Force Survey
ESAW	European Statistics on Accidents at Work
ESSPROS	European System of integrated Social Protection Statistics
EU-SILC	European Statistics of Income and Living Condition
HLY	Healthy Life Years
LMP	Labour Market Policy (labour market policy database)
SES	Structure of Earnings Survey
UOE	UNESCO, OECD, EUROSTAT (database on education statistics)
NAS	National Account Systems

1. Introduction

Labour market activities in the Member States of the European Union are usually monitored on the basis of a few key indicators published and updated regularly by Eurostat. In particular, special attention is usually given to the rate of unemployment, a measure on which Austria performs notably well as one of the countries with the lowest unemployment rates in the Union.

However, focusing on a single key determinant captures only a certain, albeit essential, aspect of the labour market and its influence on the lives of its people. Employment opportunities and national labour markets are multidimensional in nature, as labour market institutions and policies vary from country to country and each Member State faces individual challenges, strengths and weaknesses. Thus, a comparison of the labour market situations and developments of the Member States of the European Union is complex. A European comparison of labour market activities is nevertheless important; it provides for a current overview of the labour market situation across the whole of the European Union and serves as a basis of more in-depth analyses.

The comparability of national developments has been facilitated by the definition and harmonisation of key indicators as part of the European Integration, providing for the regular availability of a wide range of information on various aspects of economic and labour market developments. Such a broad view does, however, not allow for a quick overview of recent developments in the different countries of the Union. The Labour Market Monitor is an attempt to address these challenges. A team of experts from the Vienna Chamber of Labour (AK) has been working with the Austrian Institute of Economic Research (WIFO) to develop a monitoring system that condenses a large number of indicators into index scores representing certain significant aspects of labour market development that can be compared at EU level. The use of indicators that are available on a regular basis and comparable at EU level is intended to facilitate regular updates of the indices and allow for monitoring developments over time.

In 2010, to realise its aim of being able to more closely analyse a number of major labour market-related aspects in a European context, the Vienna Chamber of Labour designed the framework of the model in collaboration with the Austrian Institute of Economic Research, identifying the following five key dimensions of the labour market, which define the basic structure of the Labour Market Monitor:

1. Overall labour market performance
2. Orientation towards integration
3. Equity and continuity
4. Distribution of earnings
5. Distribution through the Welfare State

These five dimensions, referred to as “areas” in our report, are disaggregated into a varying number of sub-dimensions or “sub-areas”, measured by between 7 and 20 indicators.

The basic framework of the model is shown in the figure below.

For each of the five dimensions an index is computed, i.e. the Labour Market Monitor consists of five different indices, each of which is calculated for (essentially) all Member States of the European Union. Each index can assume a value between 1 and 10, with 10 representing the best and 1 the worst value.

Figure 1: Overview of the Labour Market Monitor Model: area indices and sub-areas

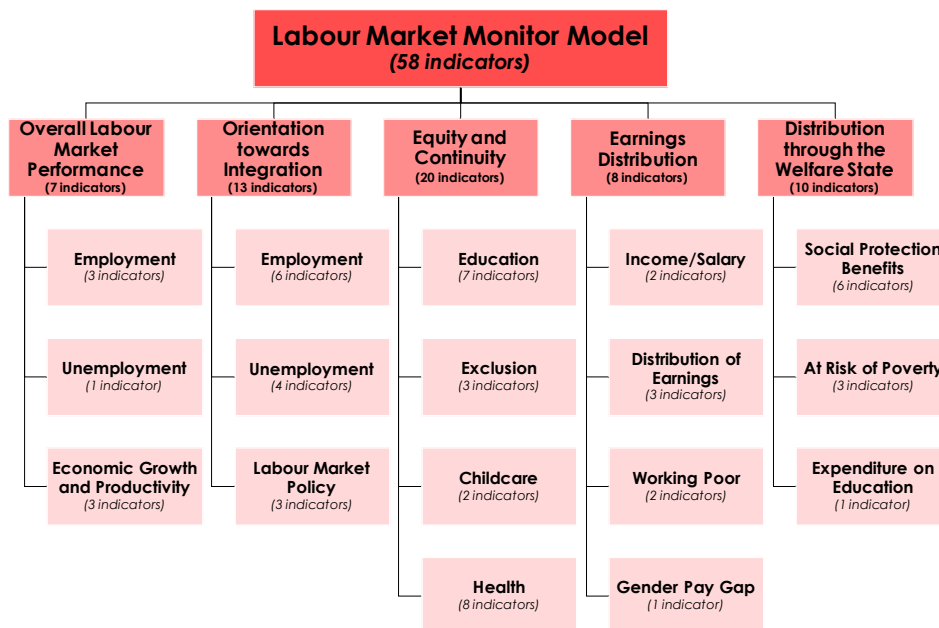

S: Eurostat, WIFO.

To allow for a Europe-wide comparison of labour market developments, a system of categorizing countries into groups has been established, depending on the point value of their score in the index. In the first classification scheme we suggest, countries are ranked in ascending order and allocated to one of four groups of the same size, i.e. “top”, “upper middle”, “lower middle” and “bottom” group. The second way of country categorization presented in this report is to form clusters of countries in such a way as to minimize the distance between the countries point values within each group, while at the same time maximize the distance to the neighboring groups.

The instrument of the Labour Market Monitor has a number of advantages. It provides for:

- the possibility of subsuming a number of complex economic, political and social inter-relations under a few index values
- a comparability of national conditions, which can also provide the basis for benchmarking
- fast and regular updates
- a descriptive overview which can serve as the basis for more in-depth analyses

However, index construction also poses challenges, such as bridging the gap between the need to transform the multidimensional complexity of the labour market into a single metric on the one hand and the aim to ensure the transparency and usability of the information subsumed on the other hand. Moreover, there is the danger of misinterpretations, which we aim to counteract by

- providing for transparency of procedures, methods and documentation of data
- enhancing the informational content by categorizing and grouping countries and
- analysing five separate aspects of the labour market.

Also, when interpreting the data, we have to bear in mind that the index system is purely descriptive in character, i.e. it has not been designed to provide evidence as to reasons for differences between countries or changes over time. The indices can, however, serve to substantially facilitate the identification of problems and questions for further analyses.

The present report is based on the second update of the index, i.e. on data compiled up to the year 2011.¹ The following chapter (chapter 2) briefly introduces the individual area indices and indicators. Chapter 3 illustrates the methodology applied in calculating the indices, which relies on methods that have been used and tested in prior research work. It is also concerned with the sources of data used and the data base to be updated and explains how missing information has been dealt with. Key findings of the updated version and changes observed in the categorization and rankings as compared to the previous year are the subject of chapter 4. The final chapter (chapter 5) offers a review of the preceding chapters. The tables of appendix A contain all major results and steps of the calculation process. A detailed overview of definitions, sources and availability of data can be found in appendix B. The results of the sensitivity analysis are presented in appendix C. Moreover, as in the 2011 report, an appendix of data tables is included.

¹ The index was first calculated in 2010 on the basis of data compiled up to and including the year 2008; the first update of the Labour Market Monitor was issued in 2011 on the basis of data compiled up to and including the year 2010.

2. Five indices to monitor the labour market

The Labour Market Monitor consists of five separate indices referred to as “area indices” in this report. In general, they capture five core dimensions of the labour market. More specifically, they can be viewed as special aspects of the labour market which constitute topics for related political discussion and debate.

The five areas remain separate, i.e. they are not aggregated or combined to form a single index (Figure 2), reflecting the variety of areas and perspectives which are of special interest and concern to the Chamber of Labour.

The five indices are constructed from indicators designed to represent the five underlying core dimensions. During the index developing process, indicators were selected and assigned to the index on the basis of expert assessment.

2.1 Five dimensions of the Labour Market Monitor

The first two areas reflect two separate general aspects of the labour market. Area index 1 provides a measure on the “overall labour market performance” of a country in the context of its general economic performance and is based on the usual key indicators, such as, e.g. the employment rate. The “orientation towards integration” index, i.e. area index 2, captures the extent to which different groups of people are integrated into the labour market.

Figure 2: Overview of the five dimensions of the Labour Market Monitor

Labour Market Monitor "Area-Indices" (58 indicators)	1	Overall Labour Market Performance (EU-27, 2011) (7 indicators)
	2	Orientation towards Integration (excl. LU & MT, 2011/2010) (13 Indicators)
	3	Equity of Access and Continuity (excl. BG & EE, 2011/2010/2009/2005) (20 Indicators)
	4	Distribution of Earnings (EU-27, 2011/2010) (8 Indicators)
	5	Distribution Welfare State (EU-27, 2011/2010/2009) (10 Indicators)

Q: Eurostat, WIFO.

The third area index, constructed as a measure of “equity of access and continuity”, has been designed to reflect the ability of a country to provide for equal access in terms of labour force participation, an area where the level of education and the availability of care services are undisputed key factors. Area indices 4 and 5 primarily illustrate disparities in income from employment and public expenditure within the European Union, with index 4 pro-

viding a measure on the “distribution of earnings” and index 5 (“distribution by the welfare state”) on the degree of effectiveness of state intervention.

2.2 The indicators behind the Labour Market Monitor

Each index is based on a varying number of individual key indicators. Thus, e.g. the index referring to the “overall performance of the labour market” is made up of 7 indicators, whereas the measure of “equality of access and continuity” is based on 20 indicators.

The following pages present the key indicators and explain the way they have been incorporated into the index. With some indicators, such as the unemployment rate, low values are associated with positive assessment, with other indicators, such as the employment rate, the higher the value the better the performance.

Area index 1 is divided into 3 sub-areas, comprising a total of 7 indicators (for details, refer to Table 1).

Table 1: Area index 1 – sub-areas and indicators

Sub-areas	All indicators	Relationship to area
Employment	<ul style="list-style-type: none"> • Employment rate (15-64 years old) • Employment rate in full-time equivalents • Employment growth compared to the previous year 	<p>+</p> <p>+</p> <p>+</p>
Unemployment	<ul style="list-style-type: none"> • Unemployment rate (15-64 years old) 	<p>-</p>
Economic growth and productivity	<ul style="list-style-type: none"> • Real GDP per capita (Euro per inhabitant) • Real GDP per capita (index 2001 = 100) • Labour productivity per person employed 	<p>+</p> <p>+</p> <p>+</p>

S: Eurostat. – Note: Column “Relationship to area”, positive relationship (+): the higher the indicator value the better and negative relationship (-): the lower the better.

The sub-area of “employment”, comprising the three indicators of employment rate, full time equivalent employment rate and “employment growth compared to the previous year”, captures the proportion of working age population employed and the current development of labour demand. Sub-area 2 (“unemployment”) is based on one indicator only, i.e. on the percentage of working age individuals unemployed (unemployment rate, age group 15-64). The third sub-area, “economic growth and productivity”, contains three indicators providing insight into the factors determining the general economic performance of a country: “real GDP per capita”, both in absolute numbers (€) and in terms of changes over time, and the “labour productivity per person employed”.

Area index 2 reflects three aspects of integration orientation within a labour market and employment system, represented by the subgroups of employment, unemployment and labour market policy, and consists of a total of 13 indicators (for details, refer to Table 2).

Table 2: Area index 2 – sub-areas and indicators

Sub-areas	All indicators	Relationship to area
Employment	• Employment rate (25-44 years old)	+
	• Employment gender gap ¹⁾ (25-44 years old)	-
	• Employment rate (55-64 years old)	+
	• Part-time employment, main reason: Could not find a full-time job	-
	• Temporary employment, main reason: Could not find a permanent job	-
	• Employment gender gap ¹⁾ (15-64 years old)	-
Unemployment	• Unemployment rate (15-24 years old)	-
	• Unemployment rate (55-64 years old)	-
	• Long-term unemployment rate (15-64 years old)	-
	• Long-term unemployment rate (55-64 years old)	-
Labour market policy	• Public expenditure on (active) labour market policies as a percentage of GDP	+
	• Public expenditure on labour market policies as a percentage of GDP per % unemployed person	+
	• Participants in active labour market policy measures/interventions as a percentage of the labour force	+

S: Eurostat, WIFO calculations. – ¹⁾ Employment gender gap = employment rate of men minus employment rate of women. Note: Column "Relationship to area", positive relationship (+): the higher the indicator value the better and negative relationship (-): the lower the better.

Sub-area 1 covers employment rates for people of different age groups, i.e. prime-age employment rates (age group 25-44) and employment rates for older workers (age group 55-64). It also comprises indicators referring to the gender gap in employment, to involuntary part time and involuntary temporary employment. Moreover, sub-area 2 focuses on the structure of unemployment and the unemployment rates for people of different age groups, such as youth unemployment, unemployment rates for older workers, long-term unemployment rate and long-term unemployment rate for older workers. Public expenditure on active labour market policies ("as a percentage of GDP" and as "a percentage of GDP per % unemployed person") and the degree of active labour market policy in terms of participation in labour market measures constitute sub-area 3.

Area index 3 is made up of twenty indicators on "equity of access and continuity", with the implicit assumption being that, across gender lines, equity and opportunity are primarily based on the four dimensions of education, exclusion, child care and health (for details, refer to Table 3).

The sub-dimension of education refers to indicators reflecting the level of education and the degree of participation in further education. The sub-dimension of exclusion contains two indicators focusing on individual care obligations and the extent of inactivity, whereas the scope of infrastructure provided by a country to support families in the care of their children is captured by the third sub-area, childcare. Finally, the sub-category of health comprises a number of indicators on the overall health condition of a country's population, especially on the health condition of its employed population.

Table 3: Area index 3 – sub-areas and indicators

Sub-areas	All indicators	Relationship to area
Education	• Early leavers from education and training	-
	• Population (25-64 years old) with low educational attainment (max. secondary level I)	-
	• Population (25-34 years old), with low educational attainment (max. secondary level I)	-
	• Population (25-64 years old), with tertiary educational attainment	+
	• Population (25-34 years old), with tertiary educational attainment	+
	• Life-long learning (Adult participation (25-64 years) in education and training)	+
	• Percentage of employees participating in continuing vocational training	+
Exclusion	• Inactive population (Out of labour force): Main reason care responsibilities	-
	• Part-time employment, main reason: Care responsibilities	-
	• Inactive population (Out of labour force)	-
Childcare	• Formal child care (children less than three years) from 1 to 29 hours weekly	+
	• Formal child care (children less than three years) 30 hours or more weekly	+
Health	• Number of fatal work-related accidents	-
	• Healthy life years at birth – women	+
	• Healthy life years at birth – men	+
	• Healthy life years at the age of 65 – women	+
	• Healthy life years at the age of 65 – men	+
	• Employed persons with disabilities	+
	• Self-perceived limitations of employed persons (severe + some limitations)	+
	• Self-perceived health of employed persons (very good + good)	+

S: Eurostat, WIFO calculations. – Note: Column “Relationship to area”, positive relationship (+): the higher the indicator value the better and negative relationship (-): the lower the better.

Area index 4 refers to the four sub-areas of income/salary, earnings distribution, working poor and gender pay gap, constituting a measure of the absolute level and distribution of earnings (Table 4). Made up of a total of eight indicators, it provides a view of the average level of earnings, the functional and personal distribution of primary income (“compensation of employees as a percentage of GDP”, “income quintile share ratio”) and the taxation on labour. Also included are gender-related income differentials as well as rates of low-wage earners and working poor.

Table 4: Area index 4 – sub-areas and indicators

Sub-areas	All indicators	Relationship to area
Income/salary	• Nominal wages per employee in PPS	+
	• Compensation of employees per capita in PPS	+
Distribution of earnings	• Compensation of employees as a percentage of GDP	+
	• Inequality of income distribution – income quintile share ratio	-
	• Taxes on labour as a percentage of total taxation	-
Working poor	• Working poor	-
	• Proportion of low wage earners (proportion of all full-time employees)	-
Gender pay gap	• Gender pay gap	-

S: Eurostat. – Note: Column “Relationship to area”, positive relationship (+): the higher the indicator value the better and negative relationship (-): the lower the better.

Area index 5 captures issues of social welfare and transfer (Table 5), with a total of ten indicators providing measures of, among others, the extent and structure of social protection bene-

fits (as a percentage of GDP) and the effects of public intervention in terms of at-risk-of-poverty rates.

Table 5: Area index 5 – sub-areas and indicators

Sub-areas	All indicators	Relationship to area
Social protection benefits	Social protection benefits as a percentage of GDP	
	• Sickness/health care	+
	• Disability	+
	• Old Age	+
	• Family/children	+
	• Unemployment/unemployment rate	+
	• Other functions (survivors, housing, social exclusion)	+
At-risk-of-poverty	• At-risk-of-poverty rate after social transfers	-
	• Improvement in the rate of at-risk-of-poverty through transfers	+
	• Relative median at-risk-of-poverty gap	-
Expenditure on education	• Total public expenditure on education as a percentage of GDP	+

S: Eurostat, WIFO calculations. – Note: Column "Relationship to area" Positive relationship (+): the higher the indicator value the better and negative relationship (-): the lower the better.

3. Data sources and methodology

From a methodological perspective, the process of index creation implies dealing with indicators of different scale and units. This is why methods of normalisation and standardization, as well as weighting play a significant role in index construction.

By comparing different viable weighting options and by analysing the response of the indices to the exclusion of individual indicators, the robustness of the indices to different ways of weighting and selecting indicators was tested by way of sensitivity analysis (cf. Haas et al., 2010).

In addition to ensuring methodological transparency, the selection of indicators which are internationally comparable and regularly available is also aimed at providing for index construction which is replicable and reproducible.

3.1 Sources of indicators

With two exceptions, Eurostat indicators form the basis for the calculation of the area indices which allow for a comparison of the labour market situation in the European Union.² For an overview as to the sources of indicators, refer to Figure 3 below.

Figure 3: Overview of the data sources used in each area indices

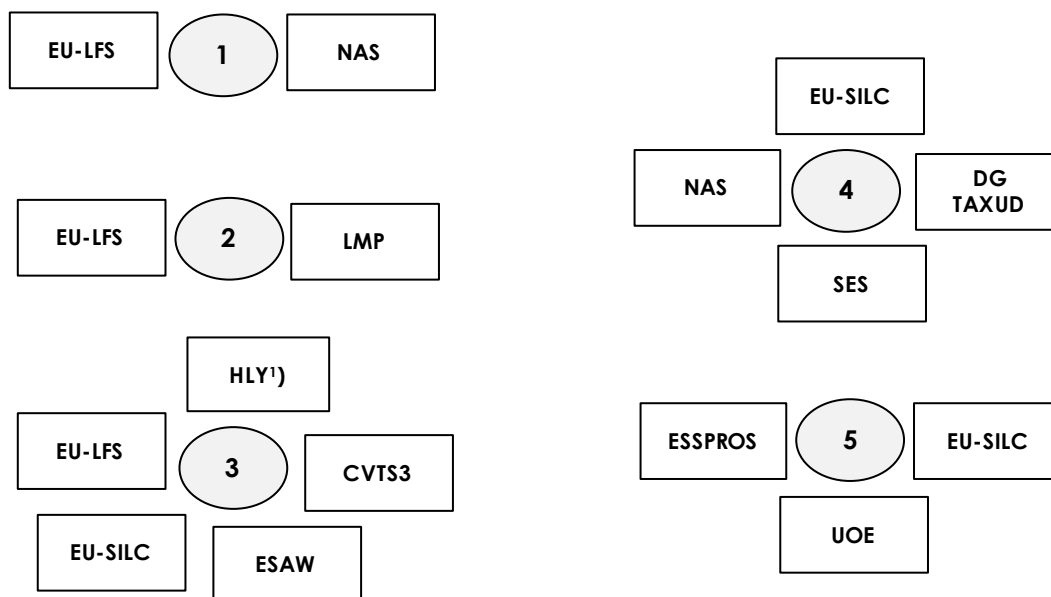

S: Eurostat, WIFO. – ¹) Area index 3: HLY (healthy life years) = structure indicator “Healthy life years” is made up of data on mortality (demographic database) and the self-assessments of disabilities (EU-SILC).

² The only indicators not taken from the Eurostat database are the indicators “employment rate in full time equivalents” of area index 1, which is based on a special analysis of the Labour Force Survey and “taxes on labour” of area index 4, which refers to “Taxation Trends in the European Union, 2012”.

3.2 Reference period for the data analysed

This year's report constitutes the second update of the Labour Market Monitor first validated and implemented by the Vienna Chamber of Labour in 2010 (*Haas et al.*, 2010), with the calculation of the area indices primarily based on data from 2011 and 2010.

Only a few indicators relevant to the calculation of the indices, such as the Structure of Earnings Survey (SES) and the Continuing Vocational Training Survey (CVTS) are not attained annually and therefore incorporated into the calculations on the basis of the most recent year of their availability. A detailed description of the reference period of all area indices can be found below. Where these periods vary in the individual Member States, the differences are pointed out accordingly. For the tables providing an overview of the coverage of publicly accessible indicators for the 27 EU Member States, refer to appendix B (tables 16-20).

Area index 1 is based on data from the year 2011. Only for Bulgaria, Poland and Romania, data for the calculation of indicators 5 and 6 on the real per capita GDP is based on the year 2010.

With the exception of the information provided on active labour market policy, which is based on data from 2010 and – in case of the United Kingdom - from 2009, the index reference period for the “integration towards orientation” index, i.e. area index 2 is 2011.

Area index 3 is based on data from 2010 and 2011 with data on vocational further training being based on 2005 and data on fatal work-related accidents on 2009 or 2007 respectively (with the latter referring to Greece). The reference period for indicator 9, “part-time employment, main reason: care responsibilities”, is 2011 with the exception of Lithuania and Latvia, where data are based on 2009.

The reference period for area index 4 is 2010 or 2011 respectively, with individual differences in some EU Member States: for Spain, the reference period for the indicator on “nominal wages per employee” is 2010, and for Portugal, 2009, as compared to 2011 for all other Member States. For Ireland, Greece, France, Italy, Cyprus, Slovakia and the United Kingdom calculations of the income quintile share ratio and the rates of working poor are based on data from 2010, with Bulgaria's period of reference for the former being 2010 as well, while for the remaining States it is 2011. In addition, while information on the proportion of low-wage earners is based on data from 2010 for all other Member States, it is 2006 for Greece. Data on the gender pay gap are from 2008 for Greece and Estonia, while they are from 2010 for all other States.

Area index 5 is primarily based on data from 2009, with “total public expenditure on education as a percentage of GDP” for Greece and Luxemburg being based on data from 2005 and 2007 respectively. By contrast, data on the working poor indicator are primarily based on 2011, with a reference year of 2010 for Ireland, Italy, Cyprus, Slovakia and the United Kingdom.

3.3 Missing values

Not each of the indicators has coverage for all of the 27 EU countries or for the most recent year. Where individual annual values are missing, attempts have been made to replace them by data from the previous year. In a few cases, where this data is not available either, no index value has been computed: Malta (MT) and Luxembourg (LU), where no time series data on the unemployment of older persons is available (as for previous reports) are not incorporated into the calculation of area index 2, "orientation towards integration". Equally, the calculation of the "equity of access and continuity" index, i.e. area index 3 does not include Bulgaria (BG) and Estonia (EE), as data on indicator 9, i.e. on part-time employment due to care responsibilities, has not been available.

3.4 Modification of individual indicators

For the present update, a few indicators have been modified as follows: Whereas for Labour Market Monitors 2010 and 2011 indicator 6 on the "real GDP per capita" of the labour market performance index, i.e. of area index 1, was calculated on a base year of 2000=100, this indicator has now been computed on a 10-year base period (year of 2001=100).

Also, for the "orientation towards integration" index, i.e. for area index 2 the concept of "older workers" has been unified to denote the 55-64 age group for all three indicators measuring the employment, unemployment and long-term unemployment rates of older workers (indicators 3, 8 and 10).

By contrast, in the previous publications, the concept of long-term unemployment rate was defined to refer to the 50-64 age group, whereas the employment and unemployment rates were defined to refer to the 55-64 age group.

3.5 Index methodology

Index construction is a sequential process. Following the selection of indicators, methods of normalization and transformation are applied to bring indicators to a common scale. Weighting is designed to ensure a balanced representation of individual indicators³ and finally, aggregation serves to combine the indicators into a final index. Essentially, there are four main developmental stages in the process of index construction, followed by sensitivity analysis.



³ Cf. Haas, S., Lutz, H. Mahringer, H. and Rückert, E., Implementierung und Testung des "Arbeitsmarktmonitors der Arbeiterkammer Wien" Wien, 2010

1. Variable normalization:

The purpose of normalization is to bring indicators with different measurement units (e.g. percentages or amounts of currencies) to a common scale. The technique applied in our research is referred to as min-max scaling, where the difference between each value and the minimum value is divided by the range.

2. Transformation:

The standardized indicators are transformed into a scale ranging from 1 to 10.

3. Weighting:

The process of weighting, applied to ensure a balanced representation of all indicators, uses the standard deviation of the individual country values from the mean value. Weighting factors are computed on the basis of a change of one percentage point in the standard deviation of an indicator.⁴ In case, e.g. the standard deviation is high, the weight decreases accordingly, thus making sure that indicators with a higher variation are not represented disproportionately higher or exert a higher influence on the overall area index.⁵

4. Aggregation:

Finally, the values derived as a result of steps 1 to 3 are summed up for each area index and standardized and transformed again, thus aggregating the individual indicators together to create an index number for each country and each dimension.

Finally, to assess the robustness of our results and the reliability of our model, we performed sensitivity analysis, comparing our original methodology to alternative configurations. Thus, we varied the time of reference, did calculations on the basis of the sub-indices and excluded individual indicators to observe the response of the model to these modifications. For further details on sensitivity analysis, refer to appendix C.

$$^4 W^n = \frac{0,01/\sigma x_i^n}{\sum_{i=1}^m 0,01/\sigma x_i^n}$$

⁵ In addition to the method illustrated above, the ranking of the individual Member States with respect to the different area indices was computed in additional ways: Firstly, discussion-based area divisions, i.e. subareas were used to create weighted sub-indices and, secondly, the calculations were carried out on the basis of the indicators from the previous year. Moreover, individual indicators were excluded as described in appendix C. As these data have been partly revised, some of the area indices calculated on the basis of data from the previous year might differ from last year's publication, i.e. from the Labour Market Monitor 2011. For the results of these calculation methods, refer to figures 21-27, appendix C. For a more detailed description of the calculation processes, refer to chapter 5 of Haas et al., 2010.

3.6 Country categorization

On the basis of the index scores calculated as described above and the ranking and distribution of the Member States derived therefrom, the 27 EU members are allocated to one of four groups of countries, i.e. classified in four categories. For detailed results of this categorization, refer to chapter 4.2, “Key findings by area indices”.

The group classified as “top” includes those European countries whose scores are in or above the 75th percentile. Group two is located between the median and the area below the 75th percentile, thus constituting the “upper middle” part of a respective labour market area. The third, or “lower middle” group, covers the area between the 25th percentile and the 50th percentile. Finally, the group classified as “bottom” comprises those countries whose scores are lower than the 25th percentile of the distribution. Categorizing countries in this way also allows for a comparison with the previous year. Thereby, not the changes in rankings but rather the categorization of the Member States in terms of the four groups of the distribution as described above are evaluated.

However, when forming four same-size groups, differences in the point values between neighbouring groups can be very small, with countries scoring very close to each other. Thus, a country's position could, e.g. be only slightly above the median whereas another country's position might be only slightly below it. Still the former would be classified as “upper middle” and the latter as “lower middle”. This is why considering alternative ways of categorization appears reasonable: countries can also be grouped or rather clustered in such a way as to maximize the similarity of members within each group, while at the same time maximizing the dissimilarity between groups. In other words, countries are clustered in such a way as to minimize the distance between the countries point values within each group, while at the same time maximize the distance to the neighboring groups. For details on this analysis, refer to chapter 4.3 “Alternative representation of key findings by area index”.

4. Key findings

4.1 Overview of key findings for Austria

As in the previous reports, Austria's labour market position is above EU average in four of the five areas described before. Particularly notable is Austria's ranking above the 75th percentile in the areas of "overall labour market performance", "orientation towards integration" and "distribution through the welfare state" (for details, refer to Table 6), placing it among the "top" countries of the European Union in these fields. Moreover, with an index value above the European average, and above the median, Austria assumes a respectable "upper middle" position as far as the distribution of earnings is concerned. Its ranking in the area of "equity of access and continuity" is, however, to be considered below average relative to the other Member States of the European Union.

Table 6: Distribution of the point values of the area indices

EU score distribution (scale 1-10)	Overall labour market performance	Orientation towards integration	Equity of access and continuity	Distribution of earnings	Distribution welfare state
	1	2	3	4	5
Austria	8.8	8.8	4.1	6.6	8.0
Mean	5.7	5.4	4.7	5.8	5.3
25% percentile	4.1	3.7	2.9	4.3	3.3
50% percentile	5.5	4.7	4.1	6.2	5.5
75% percentile	7.4	7.3	6.4	8.1	7.7
Standard deviation	2.3	2.4	2.3	2.5	2.5

S: Eurostat, WIFO calculations.

As compared with the results of last year's analysis, the Austrian index value has increased in the areas of "overall labour market performance" and "orientation towards integration". At the same time, however, its distance from the European mean value has decreased, reflecting, to some point, a general tendency observed as part of our findings: In both dimensions, the standard deviation is lower as compared to the previous year, i.e. scores tend to be more similar, implying a trend towards less heterogeneous countries.

Austria's distance to the European mean has also decreased in the fields of earnings distribution and social welfare (area indices 4 and 5), with both index values having fallen more than the respective European average. This has, however, not impacted upon Austria's group ranking in these areas. The standard deviation has also decreased in dimensions 4 and 5, i.e. the heterogeneity of the point values across the Member States of the European Union is lower than last year.

As for the factor of "equity of access and continuity", i.e. area index 3, Austria's index value

has risen in comparison with the previous year. As, however, other Member States of the European Union have scored higher values than the ones reached by Austria, Austria's position has been affected in so far as it is now categorized "lower middle" as opposed to "upper middle" last year. Its distance to the European mean has, however, remained the same.

The benchmark for Austria is illustrated in Figure 4 below.

Figure 4: Overview of the results of the area indices

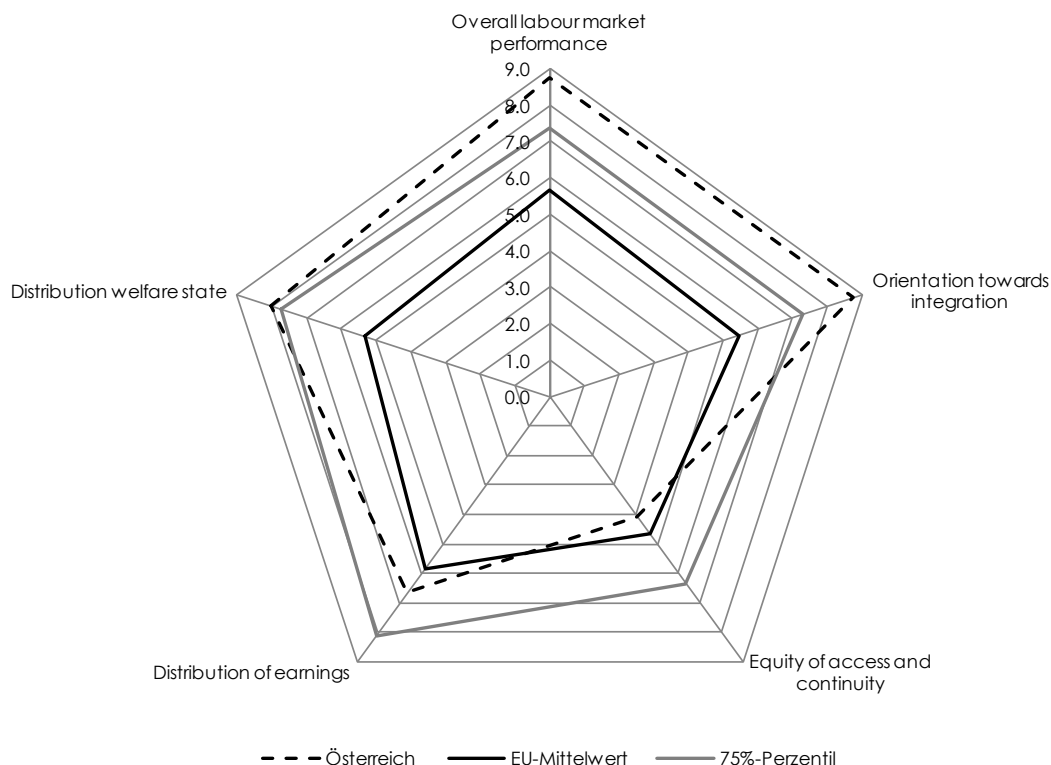

S: Eurostat, WIFO calculations.

The following sections provide for a detailed description of the findings for each of the five area indices as computed on the basis of the most recent data available. The results are mapped in figures 5-9.

4.2 Key findings by area index

4.2.1 Area index 1 – Overall Labour Market Performance

Area index 1, i.e. the “overall labour market performance index” comprises seven indicators representing the labour market performance of a country in the context of its overall economic performance (for a description of raw data, please refer to Table 29 of the appendix of data tables). The indicators subsumed under this index capture the following aspects:

- the extent of employment of the working-age population and the recent development of the demand for labour as expressed in terms of employment rate, employment rate in full-time equivalents and employment growth as compared to the previous year
- the present level of unemployment, i.e. the unemployment rate
- the economic performance of a country, i.e. economic growth and productivity as expressed in terms of real GDP per capita - both in absolute numbers (€ per inhabitant) and changes over time - and in terms of labour productivity per person employed

Key findings of the second update

As in 2010, the 2011 highest score in the overall labour market performance index was achieved by Luxembourg. And, again, the “top” group is constituted by small EU countries and Germany. Following Luxembourg, the Member States of Sweden, Austria, Denmark, Finland and the Netherlands score highest in this field (Figure 5).

The three top countries, i.e. Luxembourg, Sweden and Austria owe their rankings to different strengths: Whereas Sweden assumes the top position in the sub-area of employment, Austria ranks highest in the field of unemployment. Luxembourg's top position is due to its outstanding performance in the third sub-area, i.e. in the field of economic growth and productivity, with high levels of real GDP per capita, labour productivity and job growth and low levels of unemployment. As for its overall employment rate, its employment rate in full-time equivalents as well as for changes in the real GDP per capita, Luxembourg's index values are, however, only average in comparison with the other Member States of the Union.

With the exception of the “real GDP per capita” indicator, Austria assumes a top position on all individual measures.

The remaining leading countries are clustered at the top end of the index. Germany comes fourth, followed by Denmark, Finland and the Netherlands. The Netherlands assume a top position for employment and unemployment rates but display weaknesses in the categories of “employment rate in full-time equivalents”, “employment growth” and “real GDP per capita”.

Estonia, the United Kingdom, the Czech Republic, Cyprus, Belgium, France and Slovenia, coming behind the seven leading countries, are categorized as “upper middle”. Estonia is

second behind Sweden in the sub-area of employment but needs to catch up in the sub-areas of unemployment, economic growth and productivity. Also performing poor on the last two categories is Cyprus.

Figure 5: Area index 1 – Overall labour market performance

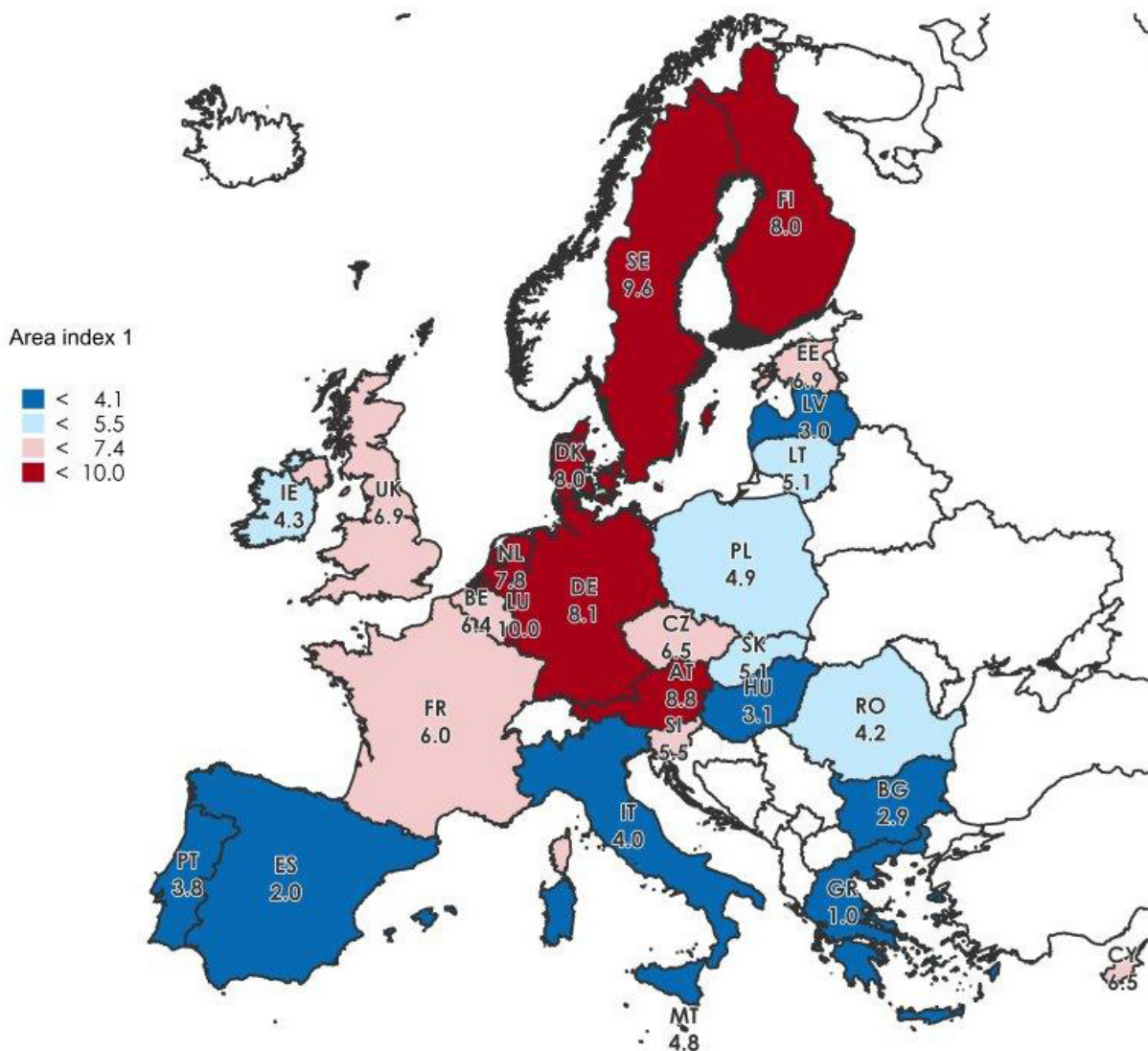

Note: The individual values make up the boundary for the next group (see Table 6): 4.1 = 25% percentile, 5.5 = 50% percentile and 7.4 = 75% percentile.

S: Eurostat, WIFO calculations.

Slovakia, Lithuania, Poland, Malta, Ireland and Romania are positioned in the “lower middle” field. While performing very strongly in the unemployment rate (15-64 years) category, Malta has one of the lowest employment rates and, consequently, a high rate of inactivity. And

Ireland, while ranking second to Luxembourg on measures of economic growth and productivity, faces considerable weaknesses in the employment and unemployment categories.

The worst-performing countries by a large margin, with scores below the 25th percentile in the area of "overall labour market performance" are Italy, Portugal, Hungary, Latvia, Bulgaria, Spain and Greece, i.e. the four Southern European countries and the three new Member States constitute the bottom category of the Union.

Changes over the reference period

As compared with the previous year, most changes can be observed at the bottom of the field. Greece, having moved from "lower middle" to "bottom" in the category of "overall labour market performance", ranks last in the table by a large margin, far apart from the remaining Member States of the European Union, thus assuming the place which was last year taken by Latvia. In particular, Greece's position relative to other Member States has seriously deteriorated in the employment rate category, causing Greece to rank last on this measure in 2011 as well as in the area of "employment rate in full-time equivalents". In addition, Greece has also fallen further behind the other countries for "employment growth" and "unemployment rate", with the second highest decline in employment after Latvia in 2011 and the second highest unemployment rate in the 15-64 age group after Spain.

Another Southern European country shaken by the financial crisis is Portugal, whose move to the bottom group is primarily due to a relative deterioration of employment indicators.

Table 7: Country categorization – Overall Labour Market Performance (Area index 1)

		Country categorization Labour Market Monitor 2012			
		Top	Upper middle	Lower middle	Bottom
Country categorization Labour Market Monitor 2011	Top	LU, SE, AT, DE, DK, NL	CY		
	Upper middle	FI	UK, CZ, BE, FR, SI	PL	
	Lower middle			SK, MT, IE, RO	PT, GR
	Bottom		EE	LT	IT, HU, LV, BG, ES
Country categorization Labour Market Monitor 2012		LU, SE, AT, DE, DK, FI, NL	EE, UK, CZ, CY, BE, FR, SI	SK, LT, PL, MT, IE, RO	IT, PT, HU, LV, BG, ES, GR

S: Eurostat, WIFO calculations. – Country categorization 2011 on the basis of updated values. Countries along the diagonal line shaded in grey have not changed the category. Countries below the diagonal line have moved down the classification and countries above the diagonal line have moved up the classification. Data on country categories of Labour Market Monitor 2012 on the basis of 2011.

By contrast, Estonia and Lithuania have been able to considerably improve on core labour market indicators. Ranking second to Sweden on the measure of employment, Estonia owes its move from the "bottom" to the "upper middle" category primarily its progress in this sub-

area of labour market performance, with top scores for "employment rate in full-time equivalents" and the highest job growth rate observed across the EU in 2011.⁶ Similarly, also Lithuania has been able to move up to another, i.e. the "lower middle" group, due to a relative improvement of employment indicators. In contrast to Estonia, however, Lithuania remains weak in the unemployment category with comparatively high unemployment rates.⁷

As for further changes in the group classified as "middle", both Poland and Cyprus have moved towards a lower classification, with Cyprus changing from "top" to "upper middle" and Poland from "upper middle" to "lower middle". It has to be noted, though, that both countries had a relatively weak starting point. In Cyprus, the downward trend is primarily due to weaknesses in the categories of "unemployment rate", "employment growth" and "real GDP per capita",⁸ in Poland, due to weaknesses in area of "employment growth". As for Poland, however, the point value of its index number has markedly increased as compared to the previous year⁹, i.e. the country's transition to the "lower middle" group has been brought about by more rapid improvements in other countries of the Union. By contrast, Finland, which had a relatively favourable starting position in 2010, moved from "upper middle" to "top" within a year because of relative improvements on the measure of unemployment and comparatively high employment growth. In general, point values in the groups classified as "top" and "upper middle" have become more homogenous as compared to the previous year, whereas "overall labour market performance" values at the bottom of the categorization tend to differ more markedly from each other, i.e. differences between "top" group countries have become relatively smaller and differences between "bottom" group countries relatively larger, with individual countries such as Greece and Spain demonstrating a very low performance as compared to the remaining EU Member States.

⁶ Estonia was already positioned in the upper middle field in 2007 and 2008. As, however, its "overall labour market performance" deteriorated considerably in 2009 and 2010, the country moved to the "bottom" group.

⁷ Although Lithuania's unemployment rate (15-64 age group) decreased from 18% in 2010 to 15.6% in 2011, the country still has the third-highest unemployment rate in the Union (based on 2011 and 2010 data).

⁸ Whereas employment growth (+0.5%) increased in Cyprus as compared to the previous year (+ 0.1%), this increase was low in comparison with other Member States, causing Cyprus to drop from the 10th to the 14th place in the ranking.

⁹ In Poland, employment increased by 1.0 % in 2011 as compared to only 0.4% in 2010. As, however, employment figures were improving more rapidly in other countries of the European Union in 2011, Poland's position as compared to other EU countries deteriorated, moving Poland down from place 7 to 11.

4.2.2 Area index 2 – Orientation towards Integration

The second area index provides a measure of different aspects of “orientation towards integration”, i.e. it captures the degree to which a labour market and employment system is able to integrate and include different groups of people. Comprising a total of 13 indicators (for raw data, refer to Table 31 of the appendix of data tables), it focuses on the following aspects:

- the employment structure, i.e. employment rates of various age groups, employment gender gaps, involuntary part-time employment, involuntary temporary employment
- the structure of unemployment or unemployment of individual groups, i.e. rate of youth unemployment or older people respectively, long-term unemployment rate and long-term unemployment rate for older people
- the activity level of active labour market policies, i.e. expenditure as a percentage of GDP and as a percentage of GDP per % unemployed person and participation in labour market measures

Malta (MT) and Luxembourg (LU) are not incorporated into the calculation of area index 2, “orientation towards inclusion”, as there is no data available on the unemployment rate for older workers, i.e. on the unemployment rate of age group 55-64 as well as on the long-term unemployment rate of the same age group.

Key findings of the second update

Whereas Greece scores lowest on the measure of “orientation towards integration”, Denmark comes first in the table for this category. As previous year, the group classified as “top” in this dimension consists of small EU countries and Germany, comprising almost the same members as the group leading in the area of “overall labour market performance”. Following Denmark, the countries of Sweden, the Netherlands, Austria, Finland, Belgium and Germany score highest in the “orientation towards integration” measure, with the countries placed second to fourth, i.e. Sweden, the Netherlands and Austria, scoring very close to each other.

Austria manages to assume a top position in 8 out of 13 indicators, scoring best in the table of EU countries in the three areas of prime-age employment rate (age group 25-44), involuntary temporary employment and unemployment rate for older workers (age group 55-64). It fares less well, however, as far as the employment rate for older workers (age group 55-64), the overall employment gender gap (age group 15-64) and the prime-age employment rate (age group 25-44) is concerned, where Austria is only classified “lower middle” in comparison to other EU countries. On measures of long-term unemployment for older workers (age group 55-64), “public expenditure on active labour market policy policies as a percentage of GDP” and “participants in active labour market policy measures as percentage of the labour force” Austria is categorized as belonging to the “upper middle” group.

Figure 6: Area index 2 – Orientation towards Integration (excl. LU and MT)

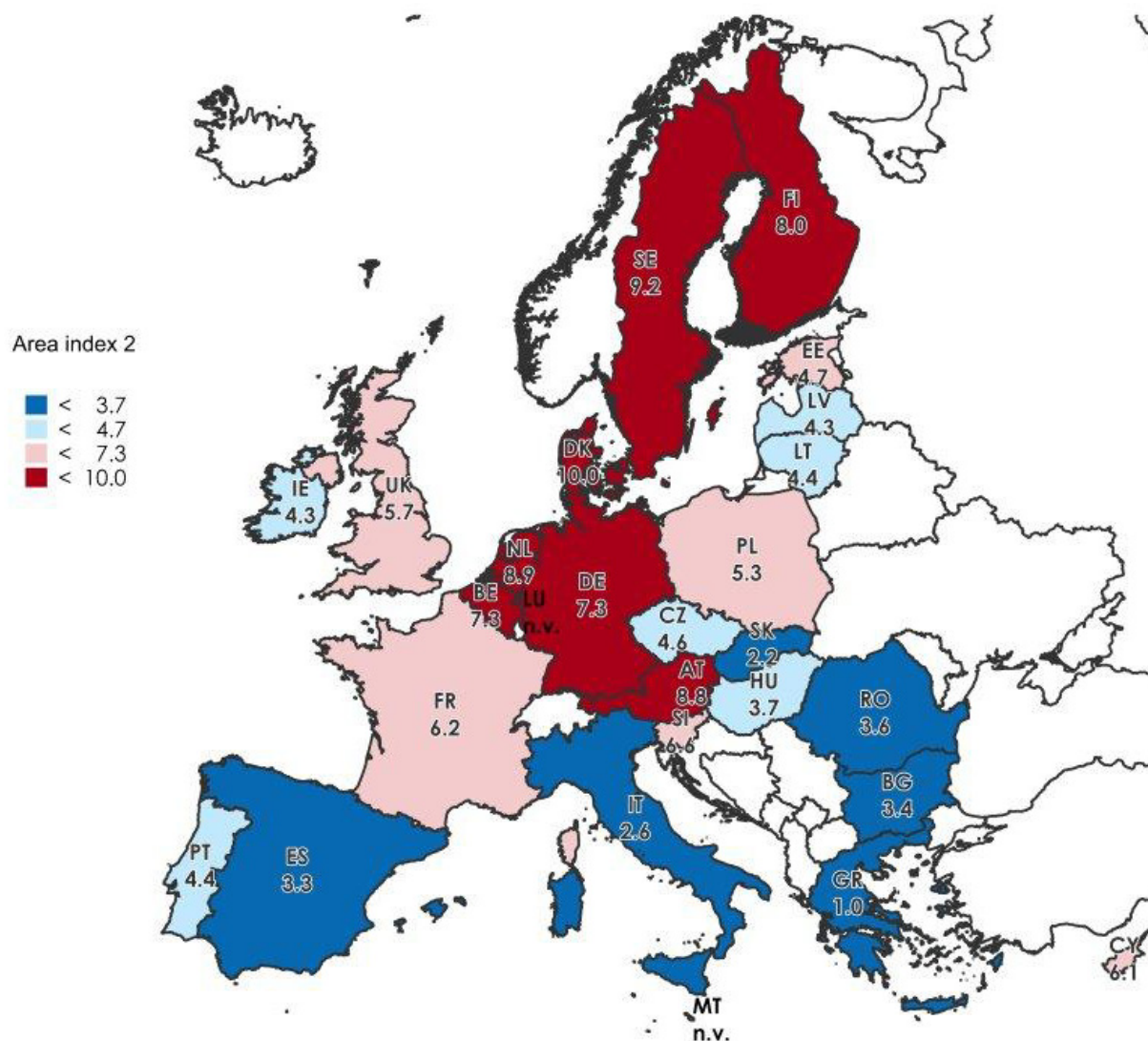

Note: The individual values make up the boundary for the next group (Table 6): 3.7 = 25% percentile, 4.7 = 50% percentile and 7.3 = 75% percentile.

S: Eurostat, WIFO calculations.

Slovenia, France, Cyprus, the United Kingdom, Poland and Estonia, coming second to the leading group of EU countries on the measure of “orientation towards integration”, are classified as “upper middle” and the Czech Republic, Lithuania, Portugal, Ireland, Latvia and Hungary as “lower middle”.

The poorest performers in the orientation integration dimension are Southern European countries and new Member States, i.e. Romania, Bulgaria, Spain, Italy, Slovakia and Greece. Yet, even some of those countries which perform comparatively poorly on this measure compared, score relatively high on individual indicators. Thus, Spain, for example, classified as

“bottom” group country, comes first in the table for the highest number of “participants in active labour market policy measures/interventions as a percentage of the labour force”. And Latvia and Lithuania, while classified as “lower middle” for their overall performance on the measure of “orientation integration”, are among the countries with the narrowest employment gender gap for the 25-44 as well as for the 15-64 age groups.

Changes over the reference period

The categorization of EU Member States into four groups on the basis of 2011 data proves relatively stable as compared to the 2010 classification.¹⁰ Only four countries have changed the category, with Estonia and Hungary moving up, and Ireland and Bulgaria moving down the classification. Whereas Estonia has moved up one place in the ranking, and, as a consequence, changed from “lower middle” to “upper middle”, Hungary has managed to move up three ranks and moved from the “bottom” to the “lower middle” category as a consequence.

Table 8: Country categorization – Orientation towards Integration (Area index 2)

		Country categorization Labour Market Monitor 2012			
		Top	Upper middle	Lower middle	Bottom
Country categorization Labour Market Monitor 2011	Top	DK, SE, NL, AT, FI, DE, BE			
	Upper middle		SI, FR, CY, UK, PL	IE	
	Lower middle		EE	CZ, PT, LV, LT	BG
	Bottom			HU	RO, ES, IT, SK, GR
Country categorization Labour Market Monitor 2012		DK, SE, NL, AT, FI, BE, DE	SI, FR, CY, UK, PL, EE	CZ, LT, PT, IE, LV, HU	RO, BG, ES, IT, SK, GR

S: Eurostat, WIFO calculations. – Country categorization 2011 on the basis of updated values. Countries along the diagonal line shaded in grey have not changed the category. Countries below the diagonal line have moved down the classification and countries above the diagonal line have moved up the classification. Data on country categories of Labour Market Monitor 2012 on the basis of 2010 and 2011.

Estonia’s shift to “upper middle” is due largely to relative improved measures of the unemployment rate in the 15-24 age group, whereas its relatively high unemployment rate in the 55-64 age group remains a weakness, despite slight improvements in the relative ranking. How-

¹⁰ For this year’s update, as compared to the previous year, one of the 13 indicators has been modified. More precisely, the concept of long-term unemployment rate for older workers has been redefined to refer to the 55-64 age group, instead of to the 50-64 age group referred to before (for details, please refer to chapters 3 and 4). This modification, has, however, not had an impact on the ranking of countries, i.e. there is no difference as to whether the “orientation towards integration” index is calculated on the basis of a long-term unemployment rate of the 55-64 age group or on the basis of the 50-64 age group: With the exception of Spain and Portugal, which have swapped rankings in the “bottom” group, rankings have remained the same.

ever, not only Estonia's unemployment rate for older workers is high. So is its employment rate (57.2%), making Estonia one of Europe's leading nations on the measure of "employment rate (age group 55-64)", with no gender-related differences. The narrow employment gender gap (age group 15-64) can be considered another strength of the Estonian labour market, even though it has widened as compared to 2010 for the prime-age group, from 0.9 to 4.9 percentage points.

Hungary's move up the classification has been due largely to its performance on labour market policies, with a relatively high percentage of "participants in active labour market policy measures/interventions as percentage of the labour force" and relatively higher "public expenditure on (active) labour market policies as a percentage of GDP per % of unemployed person".

Bulgaria's transition to the group of countries with a poor performance on "integration orientation" is primarily due to low scores on measures of "public expenditure on labour market policies", with all three individual indicators of this sub-area having worsened.

Ireland's shift to the "lower middle" category has been largely caused by its relatively poor performance on unemployment indicators.

The countries representing the top group have remained almost the same. Only the ranking within the group has partly changed. Whereas Denmark still outranks the remaining countries for "integration orientation", Sweden has been able to move up from the fourth to the second place in the table. Already classified as "top" country in 2010 on measures of labour market structure and employment, Sweden has now also been able to catch up in the sub-areas of unemployment and public expenditure on labour market policies as compared to other EU countries, moving to the second place in both categories. Sweden's strong performance in these fields has caused Austria to move down one rank in comparison with calculations based on data from the previous year despite a slightly higher point value of the index.

On the whole, the data reveal that variations at the top levels of the "orientation towards integration" index have become smaller, with higher average point values and lower amounts of dispersion.

4.2.3 Area index 3 – Equity of Access and Continuity

The "equity of access and continuity" dimension captures the degree to which employment opportunities and income target objectives are dependent on the following factors, which constitute the main determinants of labour market opportunities:

- educational opportunities
- state of health
- individual care obligations

Altogether, the index can be disaggregated into a total of 20 indicators on categories of participation in education, exclusion, childcare and health. Due to missing values for Estonia and

Bulgaria, the index has coverage for 25 countries only (for raw data, refer to Table 33 in the appendix of data tables).

Key findings of the second update

At the top of the ranking for “equity of access and continuity” are three Nordic Countries, i.e. Sweden, Denmark and Finland, with Sweden coming in first on health and educational indicators, and Denmark on the sub-areas of exclusion¹¹ and childcare. Finland performs particularly well in the field of education, ranking second after Sweden on this measure. Behind the Nordic States, also ranking in the top seven, are Luxembourg, the Netherlands, Ireland and Cyprus. Results for the top countries indicate that the Nordic States show more significant differences in their scores, whereas the countries ranked 5-7, i.e. the Netherlands, Ireland and Cyprus, score relatively close to each other. Luxembourg and Ireland do notably well in the areas of health and education and the Netherlands on childcare indicators, where it ranks second. And while performing well on the overall measure, Luxembourg, the Netherlands and Ireland are lagging behind in the sub-area of exclusion, with scores at the bottom of the distribution of European Member States.

Slovenia, the United Kingdom, Belgium, France, the Czech Republic and Spain are classified as “upper middle” in terms of this dimension, with scores above the 50th and below the 75th percentile. Austria, coming in 14th with a point value of 4.1 and positioned just below the median, as “lower middle” together with Lithuania, Germany, Greece, Poland and Latvia. Among the “middle” group countries, the United Kingdom turns out to be a notably poor performer in the “exclusion” sub-area: While categorized “upper middle” for its overall performance on the “equity of access and continuity” dimension, it scores last on “exclusion”, with the highest EU values for the indicators of “inactive population, main reason: care responsibilities” (20.6%) and “part-time employment, main reason: care responsibilities” (33.3%).

The bottom end of the “equity of access and continuity” index has remained unchanged, with Slovakia, Malta, Hungary, Italy and Portugal and Romania, i.e. two Southern European and four new Member States, facing the greatest problems in this field. Malta, however, does not score badly across all indicators. By contrast, it ranks second to Sweden for its strong performance on measures of health, especially for the indicators of “healthy life years at birth” and “healthy life years at the age of 65” for both men and women as well as for the low number of fatal work-related accidents.

¹¹ The sub-area of “exclusion” comprises two indicators, reflecting individual care responsibilities, i.e. “inactive population, main reason: care responsibilities” and “part-time employment, main reason: care responsibilities” as well as an indicator that provides a measurement of the extent of inactivity.

Figure 7: Area index 3 – Equity of access and continuity (excl. BG and EE)

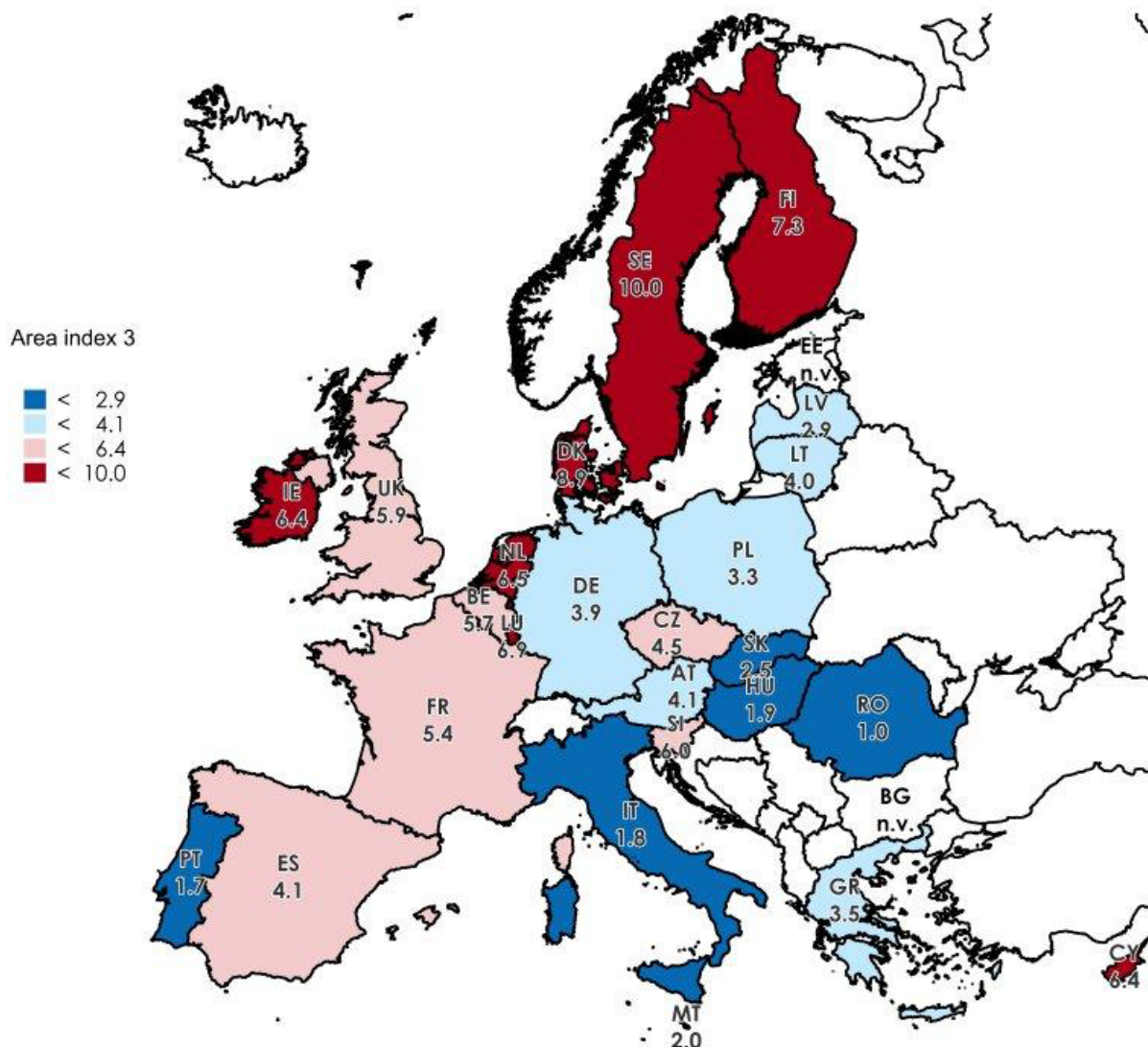

Note: The individual values make up the boundary for the next group (see Table 6): 2.9 = 25% percentile, 4.1 = 50% percentile and 6.4 = 75% percentile.

S: Eurostat, WIFO calculations.

Changes over the reference period

The classification of countries into the four groups has remained comparatively stable, with only 6 out of 25 countries changing the category (for details, refer to Table 9). Whereas Cyprus and Ireland have been able to move up to join the top countries, Slovenia and the United Kingdom have slipped in the index from top to “upper middle”. Our analysis shows that the reasons for these developments vary from country to country: Whereas Cyprus has shown improvement of its relative position especially in the sub-areas of education and exclusion, Ireland has made progress in the field of childcare and health. And while Slovenia has been

able to perform better relative to other countries on measures of education, it moves down markedly from “upper middle” to “lower middle” in the sub-area of health. This development is, however, due to methodological changes in the analysis of the data performed by Eurostat.¹² The United Kingdom moves down the classification, changing from “top” to “upper middle” in the sub-area of education and, once more, turns out to be the worst performer in the area of exclusion: No other country of the European Union has a higher rate of inactivity or part-time employment due to (child) care responsibilities.

Spain by contrast, has moved up to the same group (i.e. upper middle”), mainly because of higher scores on health measures. While having improved in this area, the country, is, however, still lagging on measures of education, where it ranks at the bottom of the index, with the second-highest score of “early leavers from education and training” and the third-highest score of people, in both the 25-64 and 25-34 age groups, with only low educational attainment (max secondary level 1). Together with the Southern European countries of Greece, Italy, Portugal and Malta, Spain ranks at the bottom of the index for these three educational indicators.

Table 9: Country categorization – Equity of Access and Continuity (Area index 3)

		Country categorization Labour Market Monitor 2012			
		Top	Upper middle	Lower middle	Bottom
Country categorization Labour Market Monitor 2011	Top	SE, DK, FI, LU, NL	SI, UK		
	Upper middle	CY, IE	BE, FR, CZ	AT	
	Lower middle		ES	LT, DE, GR, PL, LV	
	Bottom				SK, MT, HU, IT, PT, RO
Country categorization Labour Market Monitor 2012		SE, DK, FI, LU, NL, IE, CY	SI, UK, BE, FR, CZ, ES	AT, LT, DE, GR, PL, LV	SK, MT, HU, IT, PT, RO

S: Eurostat, WIFO calculations. – Country categorization 2011 on the basis of updated values. Countries along the diagonal line shaded in grey have not changed the category. Countries below the diagonal line have moved down the classification and countries above the diagonal line have moved up the classification. Data on country categories of Labour Market Monitor 2012 on the basis of 2005, 2009, 2010 and 2011.

¹² These methodological changes impact on four health indicators: “Healthy life years at birth – women” (indicator 14), “Healthy life years at birth – men” (indicator 15), “healthy life years at the age of 65 – women” (indicator 16) and “healthy life years at the age of 65 – men” (indicator 17). Due to breaks in the statistical time series incurred as a consequence of these changes, the indicators cannot be compared with data from the previous year. Without these breaks, i.e. if the update of area index 3 were calculated including the 2009 data for the four indicators, Slovenia would remain in the category of top countries, with its point value rising from 6.0 to 7.2, thus causing Slovenia to move up from the 8th to the 4th rank. The breaks also affect Italy, Portugal and Romania. For these countries, however, they do not imply group transition. All of them are at the bottom of the ranking for this dimension.

Austria has moved down the classification and is now ranking as "lower middle" for the "equity of access and continuity" category. However, although Austria's relative position has weakened, its point value has slightly increased as compared to the previous year, indicating that Austria's downward transition has been caused by the comparatively stronger performance of countries which have caught up more rapidly. Austria's relative ranking has slightly improved in the sub-areas of exclusion and health and become slightly worse in the sub-area of childcare. The relatively low extent of tertiary educational attainment in the 25-34 age group as well as the relatively high extent of part-time employment due to care responsibilities remain weaknesses of the Austrian labour market in this dimension of the index¹³.

As for part-time employment due to care responsibilities for children or adults unfit to work, gender-related measures indicate that the proportion of women in this area is considerably higher in Austria than in other European Union countries, with only the United Kingdom showing an even higher score of women.

The composition of the group with the most potential for improvement on the "equity of access and continuity" index, i.e. the group of countries classified "bottom", has remained completely unchanged as compared with the previous report, comprising Slovakia, Malta, Hungary and Romania and the Southern European countries of Italy and Portugal. The data show changes in rankings only within the group. Thus, this year Romania scores last as compared to Italy last year.

4.2.4 Area index 4 – Distribution of Earnings

The fourth area index provides a measure of the level and distribution of earnings (for raw data, refer to Table 35 of the appendix of data tables) and constitutes a composite aggregate of the following key figures:

- average level of earnings
- functional and personal distribution of primary income, i.e. wages in % of GDP, and income quintile share ratio¹⁴
- taxes on labour as a percentage of total taxation
- gender-specific wage differential
- proportion of low wage earners
- the extent of "working poor"

¹³ A closer look at the data reveals, however, that the indicators referred to have improved as compared to the previous year. As, however, other EU countries have been catching up more rapidly, Austria remains at the bottom of the distribution for these measures, ranking last but one. In comparison with 2010, the rate of the 25-34 age group with tertiary educational attainment has risen from 20.8% to 21.2%. Over the same time, the proportion of part time employment due to care responsibilities has decreased from 33.2% to 33.0%.

¹⁴ The income quintile share ratio provides a measure on the disparity of income distribution. It is defined as the ratio of the total income of the top quintile, i.e. of the total income received by the 20% of people with the highest income, to the lowest income quintile.

Altogether, this area index is made up of eight indicators, subsumed under the four sub-areas of income/salary, earnings distribution, working poor and gender pay gap.

Key findings of the second update

As previous year, Belgium manages to come in first, ahead of the remaining EU States and followed at a considerable distance by a group of small countries, i.e. Luxembourg, Denmark, Slovenia, Finland, Malta and Sweden. Belgium's leading position is due largely to its outstanding performance on indicators of income and working poor and to a relatively low gender pay gap. These results contrast with considerable weaknesses in the structure of taxation, with Belgium's taxation on labour amounting to 54.1 % of the total taxation. By comparison, this measure ranges from 32.2% (Malta) to 56.8% (Austria) within the EU.

Luxembourg ranks second to Belgium, primarily because of high scores on the indicators "nominal wages per employee in PPS" and "compensation of employees per capita in PPS". At the same time, however, Luxembourg scores among the bottom countries of the European Union for its relatively high percentage of working poor.

Denmark, ranking third, fares well across all indicators, being classified "top" or "upper middle" on most measures accordingly¹⁵, and even tops the list of EU countries for the "compensation of employees as a percentage of GDP" measure.

Slovenia, Finland, Malta and Sweden, ranking fourth to seventh, score relatively close to each other but show wide variation in their strengths: Slovenia has the lowest gender pay gap in the European Union and, together with the Czech Republic, the lowest income quintile share ratio. Finland, on the other hand, scores highly for having the lowest rate of working poor relative to the other countries of the Union, and Malta for the lowest level of taxation on labour, measured as a percentage of total taxation. Sweden scores above average across almost all indicators, with the exception of indicator 5, "taxes on labour as a percentage of total taxation", where it ranks at the bottom of the index.

France, the Netherlands, Ireland, the United Kingdom, Austria, Italy and Cyprus constitute the category classified as "upper middle". Austria scores well especially in the sub-area of income/salary and on two individual indicators: it has a relatively low rate of working poor as compared to other European countries and a relatively low income quintile share ratio. It comes last, however, on the measure of "taxes on labour as percentage of total taxation" and second to last after Estonia for the second-highest gender pay gap in the European Union.

¹⁵ The only exception is the indicator of "taxes on labour as a percentage of total taxation", where Denmark fares below the median.

Figure 8: Area index 4 – Distribution of Earnings

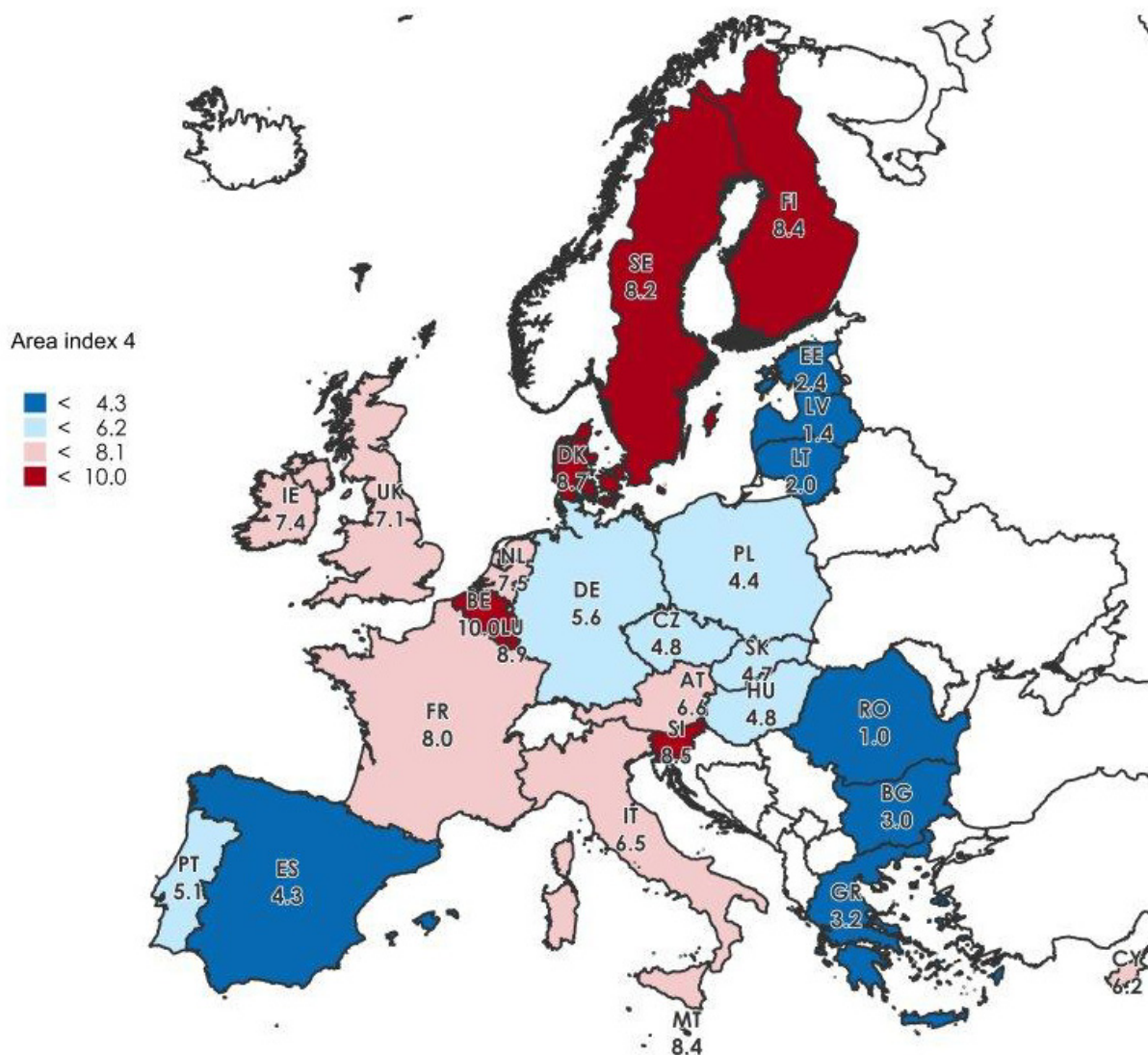

Note: The individual values make up the boundary for the next group (see Table 6): 4.3 = 25% percentile, 6.2 = 50% percentile and 8.1 = 75% percentile.

S: Eurostat, WIFO calculations.

With only one exception (Germany), the countries ranking “lower middle”, i.e. Germany, Portugal, Hungary, the Czech Republic, Slovakia and Poland, and “bottom”, i.e. Spain, Greece, Bulgaria, Estonia, Lithuania, Latvia and Romania, either belong to the Southern European States or the new Member States.

At the very bottom of the group for the level and distribution of earnings is Romania. The country does, however, not fare poorly across all indicators but does comparatively well on two measures, i.e. on “taxes on labour as a percentage of total taxation” (41.5%) and the gender pay gap, which is considerably low in Romania relative to other EU countries.

Changes over the reference period

The key findings for this index are similar to those of the previous year. The results indicate only slight changes in the categorization and grouping of the countries (for details, refer to Table 10), with Ireland and Spain having moved down a group and Sweden and Poland having moved up a group.

Austria is able to maintain position 12, although it scores lower as compared to the previous year.

Table 10: Country categorization – Distribution of Earnings (Area index 4)

		Country categorization Labour Market Monitor 2012			
		Top	Upper middle	Lower middle	Bottom
Country categorization Labour Market Monitor 2011	Top	BE, LU, DK, SI, FI, MT	IE		
	Upper middle	SE	FR, NL, UK, AT, IT, CY		
	Lower middle			DE, PT, HU, CZ, SK	ES
	Bottom			PL	GR, BG, EE, LT, LV, RO
Country categorization Labour Market Monitor 2012		BE, LU, DK, SI, FI, MT, SE	FR, NL, IE, UK, AT, IT, CY	DE, PT, HU, CZ, SK, PL	ES, GR, BG, EE, LT, LV, RO

S: Eurostat, WIFO calculations. – Country categorization 2011 on the basis of updated values. Countries along the diagonal line shaded in grey have not changed the category. Countries below the diagonal line have moved down the classification and countries above the diagonal line have moved up the classification. Data on country categories of Labour Market Monitor 2012 on the basis of 2010 and 2011.

Poland's change in the classification to "lower middle" and Spain's move down to "bottom" are by a very narrow margin: the two countries have only exchanged places as compared to the previous year, i.e. Poland comes 20th instead of 21th and Spain 21th instead of 20th Poland's higher ranking is due to relative improvements in the sub-areas of income/salary and gender pay gap. As for the latter, Poland has been able to further improve its position at the top, coming second behind Slovenia for the lowest gender pay gap in the European Union.

Sweden has been able to change from "upper middle" to "top". Its score, has however, not changed as compared to previous year. Ireland slides down from "top" to "upper middle", largely because of relatively worse scores on the sub-areas of distribution of earnings and working poor.

4.2.5 Area index 5 – Distribution by the Welfare State

The fifth dimension captures questions of social welfare and levels of transfer (for raw data, refer to Table 37 of the appendix of data tables). Comprising a total of ten indicators, it provides for:

- key figures on the extent and structure of social protection services as a percentage of the GDP
- the results of public intervention, represented in terms of at-risk-of-poverty rates
- a measure of the total public education expenditure, expressed as a percentage of GDP covering both direct government spending on educational institutions as well as subsidies to private entities

The concept of “social protection benefits” covers all forms of transfer to private households and individuals aimed at providing aid and administering needs-based support to those at social risk, especially in the fields of “Sickness/health care”, “disability”, “old age”, “family/children” as well as “unemployment”. In addition to these components, the index also contains an indicator on those functions of social protection not elsewhere classified, covering benefits to prevent social exclusion or provide support in terms of housing as well as survivors’ benefits. Expenditure-related indicators are expressed as a percentage of GDP.

The expenditure-related indicators are expressed as a percentage of GDP. Apart from a few countries, the indicators as listed above are based on the year 2009, a year which saw a decrease in GDP in all Member States except Poland. As countries do not necessarily cut down on public spending during periods of economic crisis in the same way as the GDP decreases, or are not in a position to do so, some caution will be needed when interpreting the results.

For lack of appropriate output measures, the present index is rather input-driven. As the inclusion into area 5 of expenditure-related indicators has been frequently criticised, we performed a more in-depth sensitivity analysis on this index to test the robustness of our results by jointly excluding a number of expenditure-related indices. For details of this analysis, refer to appendix C.

Key findings of the second update

Among the Member States of the European Union, a group of small countries has the strongest performance on measures of social protection and transfer. Denmark, Sweden, Finland and the Netherlands top the table in this category, joined by Austria, who ranks 5th again, as last year, Ireland and Belgium. Denmark’s strong performance is largely because of high scores in the two expenditure-related sub-areas (both expressed in % of GDP), where it is ahead of all other European countries on measures of “total public expenditure on education as a percentage of GDP” and social protection benefits related to “disability” and “family/children”. Ireland, on the other hand, is best in the third sub-area, which reflects the results of public intervention. In no other country of the European Union is there a greater difference between the at-risk-of-poverty rate before and after social transfer, and the relative median

of the at-risk-of-poverty gap is smaller in Finland only¹⁶. Ireland's high scores on these indicators contrast markedly with its poor performance in the field of social protection benefits related to "disability", a measure for which it ranks at the bottom of the Union. Similarly, whereas the Netherlands ranks top for its overall performance on social protection and transfer, it is at the lower end of the ranking on measures of social protection benefits related to "family/children".

Figure 9: Area index 5 – Distribution by the Welfare State

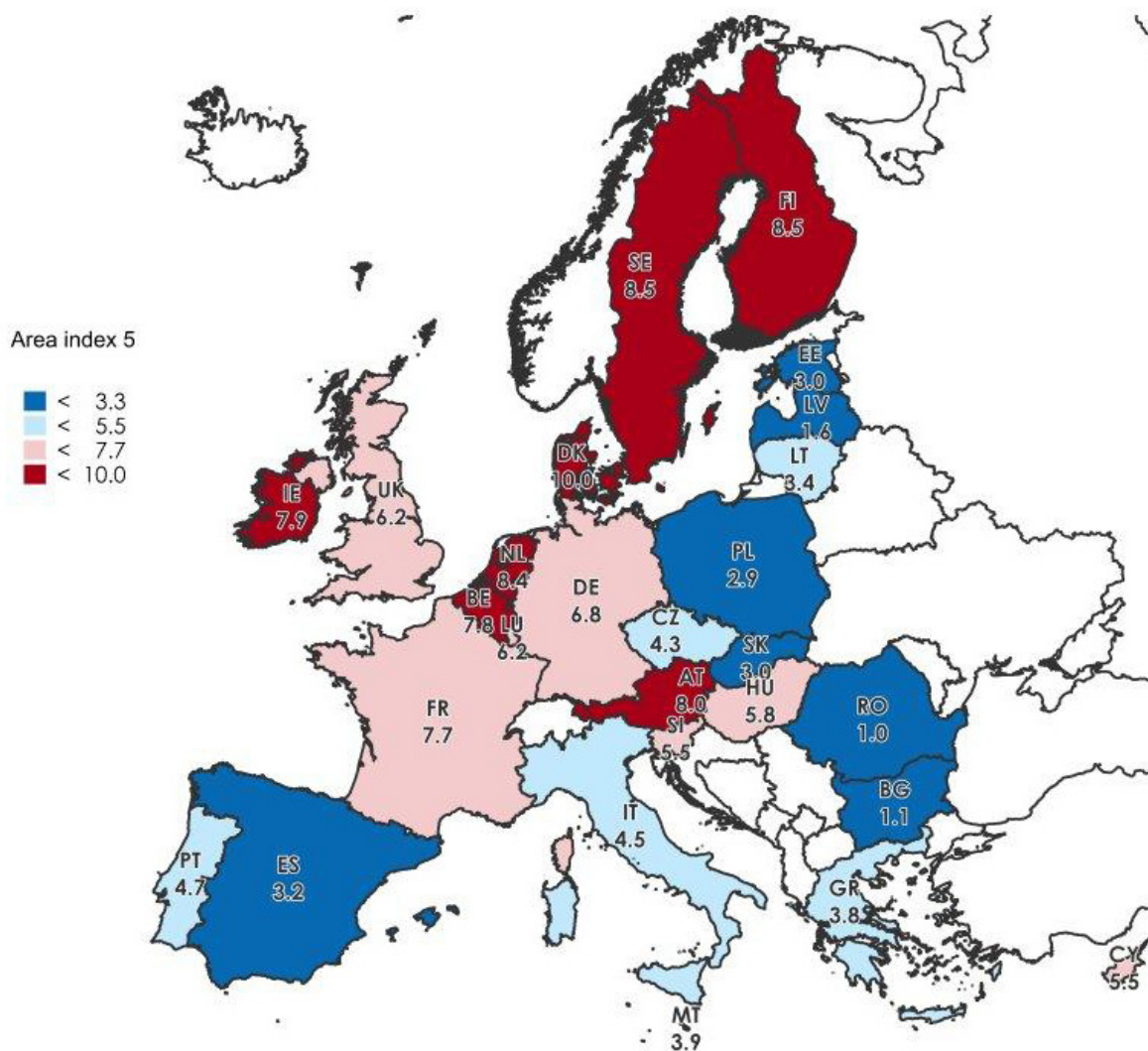

Note: The individual values make up the boundary for the next group (see Table 6): 3.3 = 25% percentile, 5.5 = 50% percentile and 7.7 = 75% percentile.

S: Eurostat, WIFO calculations.

¹⁶ The relative median of the at-risk-of-poverty gap is defined as the difference between the median of the net equivalised income of people below the at-risk-of-poverty threshold and the at-risk-of-poverty threshold, expressed as percentage of the at-risk-of-poverty threshold.

Classified as “upper middle” are the large EU Member States of France, Germany and the United Kingdom as well as Luxembourg and the new Member States of Hungary, Cyprus and Slovenia. Apart from the three States mentioned last, none of the new Member States manages to obtain a score above the median. Equally, the Southern European States of Italy, Portugal, Greece and Spain score far below the median. Irrespective of this poor performance, some of these countries fare comparatively well relative to the other European countries on measures of “at-risk-of-poverty” or do well because of their high level of expenditure on social protection and education. Thus, for example, Greece ranks among the top countries of the European Union for monetary rewards and in-kind payments related to “old age”, with a rate of 11.3% of the GDP. And the Czech Republic comes first in the table of European countries for its lowest “at-risk-of-poverty rate after social transfer” (9.8%). It is, however, classified as “lower middle” only, when its overall performance is taken into account. At the bottom of the ranking for social protection and transfer are Spain, Slovakia, Estonia, Poland, Latvia, Bulgaria and Romania, with Romania and Bulgaria scoring badly across all three sub-areas. Other countries, by contrast score comparatively well in individual sub-areas. Thus, for example, Estonia ranks among the top countries of the Union for public expenditure on education, with a rate of 6.1% of the GDP.

Changes over the reference period

The categorization of the Member States as belonging to one of the four groups of countries outlined before has remained relatively stable over time. As compared with last year’s analysis and data, only four of the 27 EU countries have moved up or down the classification. As for area index 4, this higher degree of volatility can be observed at the top and bottom of the distribution: Ireland rises up the ranks, changing from “upper middle” to “top” and thereby causing France to drop places and move to “upper middle”. Lithuania, on the other hand, moves upward to “lower middle”, whereas Poland drops places and is classified “bottom” as a consequence (Table 11). Austria still assumes a top position, coming in fifth, as last year, although its score has lowered as compared to the 2011 Labour Market Monitor report.

Ireland scores highly, largely because of an increase in expenditure on education as percentage of GDP, from 5.6% to 6.5%, thus rising up the table of European countries from 9th place to 6th. Moreover, Ireland has also improved its relative position in the field of social protection benefits as a percentage of GDP. By contrast, the position of France has deteriorated on the expenditure-related indicators of the social welfare dimension and on indicators measuring the results of intervention, i.e. on the “risk-at-poverty” measures.

Lithuania manages to move up from “bottom” to “lower middle” in the social welfare index, improving, as Ireland, on the “public expenditure on education as a percentage of GDP” indicator, with an increase from 4.9% to 5.6%, and thus on its position relative to other EU countries in this field. At the same time, Lithuania has also been able to improve more than other Member States on measures of social protection benefits as a percentage of GDP. And Pol-

and, while faring better on the at-risk-of-poverty indicators, does less well in the expenditure-related sub-areas of the social welfare index.

Table 11: Country categorization – Distribution by the Welfare State (Area index 5)

		Country categorization Labour Market Monitor 2012			
		Top	Upper middle	Lower middle	Bottom
Country categorization Labour Market Monitor 2011	Top	DK, SE, FI, NL, AT, BE	FR		
	Upper middle	IE	DE, LU, UK, HU, CY, SI		
	Lower middle			PT, IT, CZ, MT, GR	PL
	Bottom			LT	ES, SK, EE, LV, BG, RO
Country categorization Labour Market Monitor 2012		DK, SE, FI, NL, AT, IE, BE	FR, DE, LU, UK, HU, CY, SI	PT, IT, CZ, MT, GR, LT	ES, SK, EE, PL, LV, BG, RO

S: Eurostat, WIFO calculations. – Country categorization 2011 on the basis of updated values. Countries along the diagonal line shaded in grey have not changed the category. Countries below the diagonal line have moved down the classification and countries above the diagonal line have moved up the classification. Data on country categories of Labour Market Monitor 2012 on the basis of 2009, 2010 and 2011

4.3 Alternative representation of key findings by area index

In addition to the classification scheme presented before, i.e. forming four same-sized groups of countries on the basis of their scores in the individual indices, countries can also be grouped in such a way as to maximize the similarity of scores within each group while at the same time maximizing the dissimilarity of scores between groups (for an illustration of results, refer to figures 10-12).

In this chapter, we have a look at how groups of European countries form and perform, when this alternative approach is applied and discuss some of the methodological questions involved.

In short, it can be said that, across all dimensions, small European countries, especially Nordic Member States, tend to top the distribution. The Southern European States and many of the new Member States, however, tend to be located at the lower end of the ranking across the indices. In order to be better able to compare the present findings with the results from the 2011 Labour Market Monitor report, we have, following the 2011 report, decided for the minimum distance between groups to be 0.7 points (refer to Figure 10 for a representation of current data and to Figure 12 for a revised representation of last year's data).

As for the overall labour market performance index, i.e. area index 1, Luxembourg and Sweden turn out to be the best-performing countries of the European Union. At the other end of the spectrum are two countries that have been hit hard by the financial and economic crisis: Greece comes in last of all Member States by a large margin, far behind Spain, which ranks second to last in this index.

As compared to data from the previous year, the distance in point values between relatively low-performing countries has increased, whereas countries with the strongest relative performance on this measure tend to score more close to each other, i.e. whereas the differences in the measure of "overall labour market performance" have increased at the bottom of the index, they have comparatively decreased at the top: Low-performing countries are more heterogeneous in their results and high-performing countries more homogeneous.

Inclined to react and respond fast to economic change, the labour market performance index also shows most changes in rankings as compared to previous year. Austria again scores very well on this measure, leading a group of Member States in close proximity to the best-performing countries of Luxemburg and Sweden.

Key findings for area index 2, i.e. for the "orientation towards integration" index show results comparable to index 1 in terms of the variance of point values: As compared to last year, countries ranking at the top of the distribution tend have more homogenous scores compared to last year. Denmark performs best of all countries on determinants of labour market policy and on the structure of employment and unemployment. Greece, as previous year the weakest performing country of the EU, scores worst in this index by a large margin.

In the middle, as many as 19 countries have formed a large cluster of countries. As last year, Austria scores very well in this dimension grouped together with Sweden and the Netherlands immediately behind Denmark, the country which scores highest on the measure of integration orientation.

As in the previous year, "equity of access and continuity", i.e. the dimension underlying area index 3, is best in Sweden, assessed on the basis of determinants relating education, exclusion, childcare and health. Denmark ranks second on this measure, followed at a clear distance by two large groups of countries. Austria scores relatively low again and is positioned in a group of countries at the bottom of the distribution. Worst-performing country on the measure of "equity of access and continuity" according to the current data is Romania, which implies that this year in contrast to last year's results a single country rather than a group of countries forms the bottom of the ranking of European countries in this dimension.

A high degree of stability can be observed as far as the "distribution of earnings" index, i.e. area index 4 is concerned, with Belgium scoring highest again, ahead of a group of large countries, including Austria, with comparatively high point values. The lowest-scoring countries have formed a cluster comprising six Member States, which score last relative to other EU Member States on this dimension.

For the fifth dimension of the Labour Market Monitor model, "distribution by the welfare state", data reveal that the rankings at both ends of the spectrum have remained unchanged: While Denmark tops the table of European countries in terms of social protection and transfer, Latvia, Bulgaria and Romania score worst in this dimension. Between these two ends of the spectrum three groups of approximately the same size have formed, with Austria

belonging to the group positioned in close proximity to the best-performing Member State in the social welfare category, i.e. Denmark.

As pointed out at the beginning of this chapter, the methodological approach presented here implies that a decision as to when to declare two or more countries to be members of the same group has to be taken. Our results indicate that taking a value of 0.7 points to determine the minimum distance between groups as described above, imposes some limitations on data interpretation: Upon a distance of 0.7 two very large groups form in areas 2 and 4, ranging from scores of 2.2 to 7.3 in index 2 and from 4.3 to 8.9 in index 4 respectively. This is why we have decided for a second representation on the basis of a minimum distance of 0.6 (for detailed illustrations, refer to Figure 11). Upon modification of the distance to 0.6, an additional group forms in the “overall labour market performance” dimension, i.e. in area index 1 as well as in the category of “distribution by the welfare state”, i.e. in area index 5. In area index 1, Austria forms an own group, behind Luxembourg and Sweden and ahead of Germany, Denmark, Finland and the Netherlands. In area index 5, Germany, ranking 9th, constitutes a group of its own.

And whereas the change of the minimum distance value leaves area index 3, i.e. “equity of access and continuity” unchanged, it proves to have major impacts on the “orientation towards integration” dimension, i.e. on area index 2: Instead of five country groups formed upon a distance 0.7, eight country groups form, when the minimum distance is changed to 0.6. From the group comprising 19 countries located in the middle of the distribution under the 0.7 condition, four individual groups emerge upon the modification of the distance to 0.6. And whereas Germany and Belgium constitute the top, at a considerable distance from other EU countries, Italy and Slovakia form the bottom, with the remaining 15 countries forming two groups of their own.

Comparable developments brought about by a modification of the minimum distance to 0.6 can be observed for the fourth dimension of the Labour Market Monitor, i.e. the “distribution of earnings” category. Five country groups develop instead of three, with the originally large middle field dividing to form two separate groups. Also, the bottom group of the index has divided into two groups, leaving Latvia and Romania behind as countries with the highest potential for improvement.

Figure 10: Index calculation 2012 – Country groupings by area index with minimum distance of 0.7 points

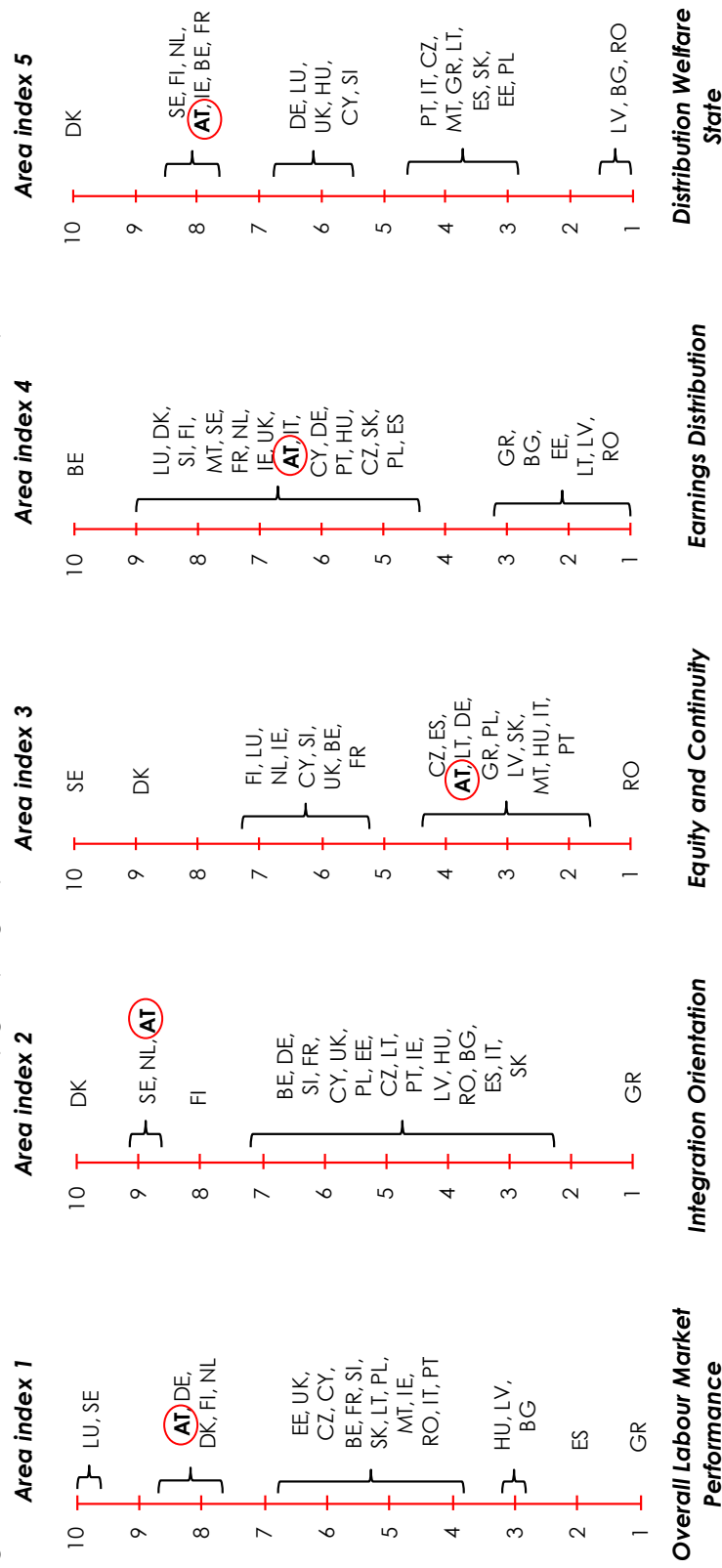

Note: Numbers on axes denote scores in area indices. For each index, 1 is the minimum and 10 the maximum value. Countries are grouped in terms of their distance to the next cluster. Countries are regarded to be a new group when their distance to the next group is at least 0.7 points, with the distance being computed on the basis of the distribution of scores in the respective areas. Within groups, countries are ranked in descending order of their scores.

S: Eurostat, WIFO calculations.

Figure 11: Index calculation 2012 – Country groupings by area index with minimum distance of 0.6 points

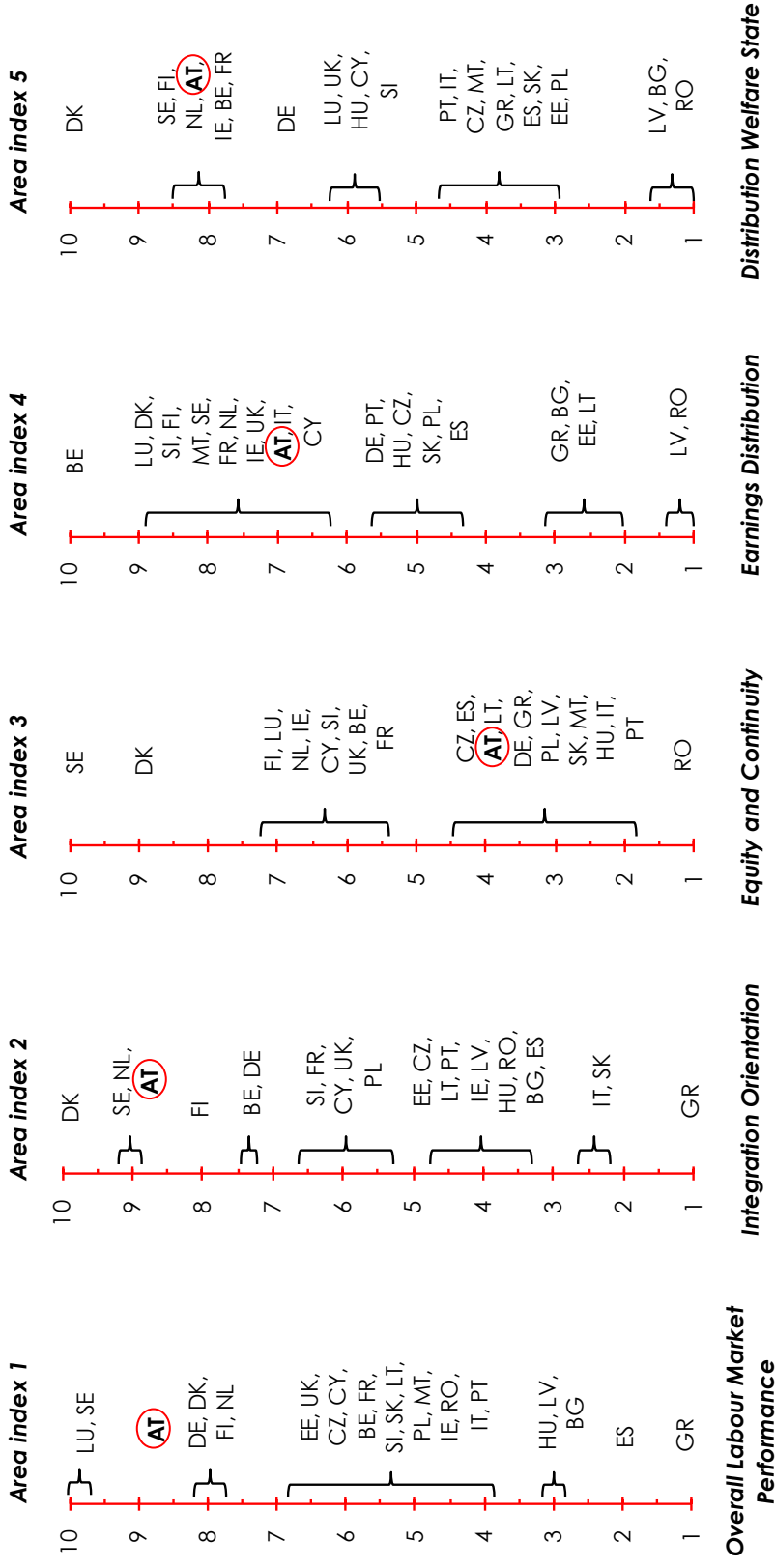

Note: Numbers on axes denote scores in area indices. For each index, 1 is the minimum and 10 the maximum value. Countries are grouped in terms of their distance to the next cluster. Countries are regarded to be a new group when their distance to the next group is at least 0.6 points, with the distance being computed on the basis of the distribution of scores in the respective areas. Within groups, countries are ranked in descending order of their scores.

S: Eurostat, WIFO calculations.



Figure 12: Index calculation 2011 – Country groupings by area index on basis of revised data

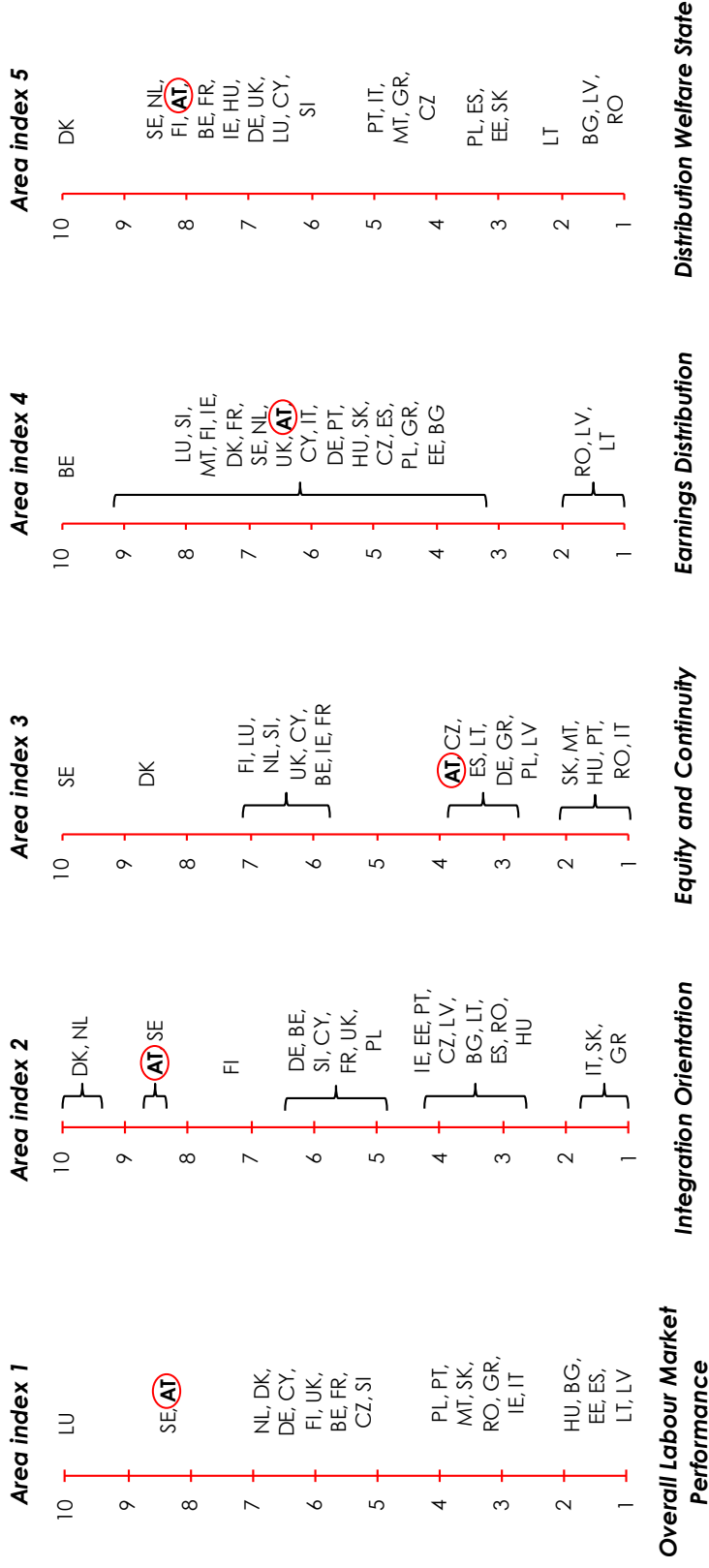

Note: Numbers on axes denote scores in area indices. For each index, 1 is the minimum and 10 the maximum value. Countries are grouped in terms of their distance to the next cluster. Countries are regarded to be a new group when their distance to the next group is at least 0.7 points, with the distance being computed on the basis of the distribution of scores in the respective areas. Within groups, countries are ranked in descending order of their scores. Calculations are on the basis of indicators from the previous year, which is why area indices might differ from last year's publication.

How to read the scales: In the Overall Labour Market Performance dimension (Area Index 1), for example, a new group of countries with above-average performance is formed, following the top group of Luxembourg, Sweden and Austria. This new group comprises the Netherlands, Denmark, Germany, Cyprus, Finland, the United Kingdom, Belgium, France, the Czech Republic and Slovenia.

S: Eurostat, WIFO calculations.

5. Summary

This year's update of our report, primarily analysing data from 2010 and 2011, is based on the Labour Market Monitor model developed and validated by a team of experts of the Vienna Chamber of Labour (AK) in cooperation with the Austrian Institute of Economic Research (WIFO) in 2010. The tool comprises five indices, capturing five core dimensions of the labour market, and is aimed at monitoring labour market activities in the 27 Member States of the European Union. While area index 1 measures the "overall labour market performance" of a country, area indices 2 and 3 provide insight into its levels of "orientation towards integration" and "equity of access and continuity", respectively. Area index 4 covers the "distribution of earnings" and area index 5 the "distribution by the welfare state". The five indices are not combined to form a composite index but rather remain separate. Thus, the considerable impact of financial and economic crisis on those labour market areas highly responsive to economic change comes clear. Key determinants in this context are primarily defined by the "overall labour market performance" index, an area which shows the highest degree of volatility and most changes in rankings as compared to the previous year. By contrast, those dimensions of the Labour Market Monitor which capture rather structural and institutional factors are characterized by comparatively minor changes in country groupings and positions.

On the whole, the evaluation of our data shows that, across all dimensions, small European countries, especially Nordic Member States, tend to assume a leading position, whereas the Southern European States and many of the new Member States tend to be located at the lower end of the distributions.

Austria remains among the top countries of the European Union on measures of dimensions 1, 2 and 5, i.e. "overall labour market performance", "orientation towards integration" and "social welfare" and is able to retain a steady "upper middle" position in the "distribution of earnings" indicator. Thus, our findings indicate that Austria's performance is again above EU average in four of the five LMM dimensions. By contrast, Austria scores below average in the area of "equity of access and continuity", lagging further behind other European countries. Although a number of indicators have slightly improved, other Member States have been catching up more rapidly, causing Austria to score markedly below other European countries, especially on measures of "formal child care (children younger than three years)", "population with tertiary educational attainment" and "healthy life years at birth and at the age of 65". Moreover, Austria also performs poorly on the indicators measuring inactivity or part-time employment due to care obligations.

References

- Belitz, H., Werwatz, A., Innovationsfähigkeit: Deutschland unter den führenden Industrieländern nur im Mittelfeld, DIW Wochenbericht, 2005, (49).
- Bierhanzl, E., Lawson, R. A., Labor Market Flexibility: An Index Approach to Cross-Country Comparisons, Journal of Labor Research, Winter 2004, XXV(1), S. 117-126.
- Engelbrech, G., Kopel, M., Gender-Index – eine Landkarte für Deutschland, Hans Böckler Stiftung, Arbeitspapier, April 2007, (136).
- European Commission, Taxation Trends in the European Union, Data for the EU Member States, Iceland and Norway, 2012.
- European Commission, Indicators for monitoring the Employment Guidelines including indicators for additional employment analysis, 2010 compendium.
- European Commission, Report on Equality between women and men 2010.
- Europäische Kommission, Datenbank zur Arbeitsmarktpolitik, Methodik, überarbeitete Fassung vom Juni 2006, 2006.
- Europäische Kommission, ESSOSS-Handbuch, Das Europäische System der Integrierten Sozialschutzstatistik (ESSOSS), Ausgabe 2008.
- Haas, S., Lutz, H., Mahringer, H. und Rückert, E., Implementierung und Testung des „Arbeitsmarktmonitors der Arbeiterkammer Wien“, Wien, 2010.
- Haas, S., Lutz, H., Mahringer, H. und Rückert, E., Arbeitsmarktmonitor 2011 – ein jährliches, EU-weites Arbeitsmarktbeobachtungssystem, Wien, 2011.
- Kammer für Arbeiter und Angestellte für Oberösterreich, Gewinne Explodieren, Löhne Stagnieren: Kaufkraft Stärken, Wachstum Fördern! Daten zur aktuellen Einkommensverteilung, Linz, 2006.
- Kammer für Arbeiter und Angestellte für Oberösterreich, Höhere Löhne und Gehälter Bringen Wachstum und Beschäftigung, Linz, 2005.
- Kammer für Arbeiter und Angestellte für Wien und Österreichisches Institut für Wirtschaftsforschung, Arbeitsmarktmonitor, Kurzfassung, Dezember, 2010.
- OECD, Handbook on Constructing Composite Indicators, Methodology and User Guide, Paris, 2008.
- Statistik Austria, Standard-Dokumentation, Metainformationen, Definitionen, Erläuterungen, Methoden, Qualität zur Arbeitskräfteerhebung 2003, Wien, 2004.
- Statistik Austria (2009A), Verdienststrukturerhebung, Struktur und Verteilung der Verdienste in Österreich, Wien, 2009.
- Statistik Austria (2009B), Standard-Dokumentation, Metainformationen, Definitionen, Erläuterungen, Methoden, Qualität zur Europäischen Erhebung über betriebliche Bildung (CVTS3), Wien, 2009.
- Statistik Austria (2010A), Standard-Dokumentation, Metainformationen, Definitionen, Erläuterungen, Methoden, Qualität zu der Volkswirtschaftlichen Gesamtrechnung, VGR – Jahresrechnung, Wien, 2010.
- Statistik Austria (2010B), Standard-Dokumentation, Metainformationen, Definitionen, Erläuterungen, Methoden, Qualität zu EU-SILC 2008, Wien, 2010.
- Statistik Austria (2010C), Standard-Dokumentation, Metainformationen, Definitionen, Erläuterungen, Methoden, Qualität zu ESSOSS (Europäisches System der Integrierten Sozialschutzstatistik), Wien, 2010.
- Wallner, J., Gestaltung und Finanzierung von Arbeitsmarktpolitik: Ein Internationaler Vergleich, Kammer für Arbeiter und Angestellte für Wien, Wien, Jänner 2008.

Appendix A – Significant results and calculation steps

Table 12: List of indicators

Areas indices and indicators		Year ¹⁾	Source	Eurostat online data code	Missing countries
Area index 1: Overall Labour Market Performance					
1	Employment rate (15-64 years old)	2011	EU-LFS	lfsa_ergan	
2	Employment rate in full-time equivalents	2011	EU-LFS	Eurostat	
3	Employment growth compared to the previous year	2011	NAS/EU-LFS	lfsi_grt_a = tps00180	
4	Unemployment rate (15-64 years old)	2011	EU-LFS	lfsa_urgan	
5	Real GDP per capita (€ per inhabitant)	2011	NAS	nama_aux_gph	
6	Real GDP per capita (index 2001 = 100)	2011	NAS	nama_aux_gph	
7	Labour productivity per person employed	2011	NAS	nama_aux_lp = tec00116	
Area index 2: Orientation towards Integration (excl. LU and MT)					
1	Employment rate (25-44 years old)	2011	EU-LFS	lfsa_pganws	
2	Employment gender gap: Difference between male and female employment rates (25-44 years old)	2011	EU-LFS	lfsa_pganws	
3	Employment rate (55-64 years old)	2011	EU-LFS	lfsa_ergan	
4	Part-time employment, main reason: Could not find a full-time job	2011	EU-LFS	lfsa_epgar	
5	Temporary employment, main reason: Could not find a permanent job	2011	EU-LFS	lfsa_etgar	
6	Employment gender gap: Difference between male and female employment rates (15-64 years old)	2011	EU-LFS	lfsa_ergan	
7	Unemployment rate (15-24 years old)	2011	EU-LFS	lfsa_urgan	
8	Unemployment rate (55-64 years old)	2011	EU-LFS	lfsa_urgan	LU, MT
9	Long-term unemployment rate (15-64 years old)	2011	EU-LFS	lfsa_upgal	
10	Long-term unemployment rate (55-64 years old)	2011	EU-LFS	lfsa_upgal	LU, MT
11	Public expenditure on (active) labour market policies as a percentage of GDP	2010	LMP	lmp_expsumm	
12	Public expenditure on labour market policies as a percentage of GDP per % unemployed person	2010	LMP	lmp_expsumm / lfsa_urgan	
13	Participants in active labour market policy measures/interventions as a percentage of the labour force	2010	LMP	lmp_partsumm / lfsa_agan	
Area index 3: Equity of Access and Continuity (excl. BG and EE)					
1	Early leavers from education and training	2011	EU-LFS	edat_lfse_14	
2	Population (25-64 years old) with low educational attainment (max. secondary level I)	2011	EU-LFS	edat_lfs_9903	
3	Population (25-34 years old), with low educational attainment (max. secondary level I)	2011	EU-LFS	edat_lfs_9903	
4	Population (25-64 years old), with tertiary educational attainment	2011	EU-LFS	edat_lfs_9903	
5	Population (25-34 years old), with tertiary educational attainment	2011	EU-LFS	edat_lfs_9903	
6	Life-long learning (Adult participation (25-64 years) in education and training)	2011	EU-LFS	trng_lfs_01	
7	Percentage of employees participating in continuing vocational training	2005	CVTS3	trng_cvts3_41	
8	Inactive population (Out of labour force): Main reason care responsibilities	2011	EU-LFS	lfsa_igar	
9	Part-time employment, main reason: Care responsibilities	2011	EU-LFS	lfsa_epgar	BG, EE
10	Inactive population (Out of labour force)	2011	EU-LFS	lfsa_ipga	
11	Formal child care (children less than three years) from 1 to 29 hours weekly	2010	EU-SILC	ilc_caindformal	

Areas indices and indicators		Year ¹⁾	Source	Eurostat online data code	Missing countries
12	Formal child care (children less than three years) 30 hours or more weekly	2010	EU-SILC	ilc_caindformal	
13	Number of fatal work-related accidents	2009	ESAW	hsw_aw_nnasx & hsw_mi01	
14	Healthy life years at birth – women	2010	Demo-	hlth_hlye	
15	Healthy life years at birth – men	2010	graphical	hlth_hlye	
16	Healthy life years at the age of 65 – women	2010	data-	hlth_hlye	
17	Healthy life years at the age of 65 – men	2010	base and	hlth_hlye	
18	Employed persons with disabilities	2010	EU-SILC	hlth_silc_04	
19	Self-perceived limitations of employed persons (severe + some limitations)	2010	EU-SILC	hlth_silc_06	
20	Self-perceived health of employed persons (very good + good)	2010	EU-SILC	hlth_silc_01	

Area index 4: Distribution of Earnings

1	Nominal wages per employee in PPS	2011	NAS	nama_nace06_c & e	
2	Compensation of employees per capita in PPS	2011	NAS	nama_nace06_c & e	
3	Compensation of employees as a percentage of GDP	2011	NAS	nama_gdp_c	
4	Inequality of income distribution – income quintile share ratio	2011 ³⁾	EU-SILC	ilc_di11	
5	Taxes on labour as a percentage of total taxation	2010	DG TAXUD	Taxation Trends, 2012	
6	Working poor	2011 ³⁾	EU-SILC	ilc_iw01	
7	Proportion of low wage earners (full-time employees)	2010	VSE	earn_ses_ade ci	
8	Gender pay gap	2010	VSE	tsiem040	

Area index 5: Distribution by the Welfare State

Social protection benefits as a percentage of GDP (1-6)

1	Sickness/health care	2009	ESSPROS	spr_exp_gdp	
2	Disability	2009	ESSPROS	spr_exp_gdp	
3	Old Age	2009	ESSPROS	spr_exp_gdp	
4	Family/children	2009	ESSPROS	spr_exp_gdp	
5	Unemployment/unemployment rate	2009	ESSPROS	spr_exp_gdp	
6	Other functions (survivors, housing, social exclusion)	2009	ESSPROS	spr_exp_gdp	
7	At-risk-of-poverty rate after social transfers	2011 ³⁾	EU-SILC	ilc_li02	
8	Improvement in the rate of at-risk-of-poverty through transfers	2011 ³⁾	EU-SILC	ilc_li10-ilc_li02	
9	Relative median at-risk-of-poverty gap	2011 ³⁾	EU-SILC	ilc_li11	
10	Total public expenditure on education as a percentage of GDP	2009	UOE	educ_figdp	

S: Eurostat. – ¹⁾ column year: The last available year which enters each index. – ²⁾ Area index 3 (14-17): Structural indicators “Healthy Life Years”. Eurostat mortality statistics and data on self-assessment of disability (EU-SILC) are incorporated into the calculation of healthy life years. – ³⁾ Or last available year (2010).

Table 13: Indicators and weights

Areas indices and indicators		Valu- ation	Standard deviation	0.01/ Standard deviation	Weight
Area index 1: Overall Labour Market Performance					
1	Employment rate (15-64 years old)	+	2.79	0.00359	0.115
2	Employment rate in full-time equivalents	+	2.49	0.00401	0.128
3	Employment growth compared to the previous year	+	1.76	0.00570	0.182
4	Unemployment rate (15-64 years old)	-	2.23	0.00449	0.143
5	Real GDP per capita (€ per inhabitant)	+	2.06	0.00485	0.155
6	Real GDP per capita (index 2001 = 100)	+	2.69	0.00372	0.119
7	Labour productivity per person employed	+	2.02	0.00496	0.158
	Total			0.03132	1.000
Area index 2: Orientation towards Integration (excl. LU and MT)					
1	Employment rate (25-44 years old)	+	2.85	0.00351	0.065
2	Employment gender gap: Difference between male and female employment rates (25-44 years old)	-	2.50	0.00400	0.074
3	Employment rate (55-64 years old)	+	2.13	0.00468	0.087
4	Part-time employment, main reason: Could not find a full-time job	-	2.86	0.00349	0.065
5	Temporary employment, main reason: Could not find a permanent job	-	2.22	0.00451	0.084
6	Employment gender gap: Difference between male and female employment rates (15-64 years old)	-	2.28	0.00438	0.081
7	Unemployment rate (15-24 years old)	-	2.24	0.00447	0.083
8	Unemployment rate (55-64 years old)	-	2.63	0.00381	0.071
9	Long-term unemployment rate (15-64 years old)	-	2.38	0.00420	0.078
10	Long-term unemployment rate (55-64 years old)	-	2.38	0.00420	0.078
11	Public expenditure on (active) labour market policies as a percentage of GDP	+	2.34	0.00427	0.079
12	Public expenditure on labour market policies as a percentage of GDP per % unemployed person	+	2.68	0.00374	0.069
13	Participants in active labour market policy measures/interventions as a percentage of the labour force	+	2.20	0.00455	0.085
	Total			0.05380	1.000
Area index 3: Equity of Access and Continuity (excl. BG and EE)					
1	Early leavers from education and training	-	2.17	0.00462	0.054
2	Population (25-64 years old) with low educational attainment (max. secondary level I)	-	2.35	0.00426	0.050
3	Population (25-34 years old), with low educational attainment (max. secondary level I)	-	2.21	0.00452	0.053
4	Population (25-64 years old), with tertiary educational attainment	+	3.03	0.00330	0.038
5	Population (25-34 years old), with tertiary educational attainment	+	2.83	0.00354	0.041
6	Life-long learning (Adult participation (25-64 years) in education and training)	+	2.25	0.00444	0.052
7	Percentage of employees participating in continuing vocational training	+	2.48	0.00403	0.047
8	Inactive population (Out of labour force): Main reason care responsibilities	-	2.23	0.00448	0.052
9	Part-time employment, main reason: Care responsibilities	-	2.92	0.00342	0.040
10	Inactive population (Out of labour force)	-	2.61	0.00383	0.045
11	Formal child care (children less than three years) from 1 to 29 hours weekly	+	2.18	0.00460	0.054
12	Formal child care (children less than three years) 30 hours or more weekly	+	1.97	0.00508	0.059
13	Number of fatal work-related accidents	-	2.55	0.00392	0.046

Areas indices and indicators		Valu- ation	Standard deviation	0.01/ Standard deviation	Weight
14	Healthy life years at birth – women	+	2.28	0.00438	0.051
15	Healthy life years at birth – men	+	2.36	0.00423	0.049
16	Healthy life years at the age of 65 – women	+	2.01	0.00497	0.058
17	Healthy life years at the age of 65 – men	+	2.11	0.00474	0.055
18	Employed persons with disabilities	+	1.99	0.00501	0.058
19	Self-perceived limitations of employed persons (severe + some limitations)	+	2.27	0.00440	0.051
20	Self-perceived health of employed persons (very good + good)	+	2.42	0.00414	0.048
	Total			0.08591	1.000
Area index 4: Distribution of Earnings					
1	Nominal wages per employee in PPS	+	2.42	0.00413	0.129
2	Compensation of employees per capita in PPS	+	2.51	0.00398	0.125
3	Compensation of employees as a percentage of GDP	+	2.71	0.00369	0.116
4	Inequality of income distribution – income quintile share ratio	-	2.73	0.00366	0.115
5	Taxes on labour as a percentage of total taxation	-	2.84	0.00352	0.110
6	Working poor	-	1.98	0.00505	0.158
7	Proportion of low wage earners (full-time employees)	-	2.62	0.00381	0.120
8	Gender pay gap	-	2.46	0.00406	0.127
	Total			0.03189	1.000
Area index 5: Distribution by the Welfare State					
Social protection benefits as a percentage of GDP (1-6)					
1	Sickness/health care	+	2.50	0.00400	0.091
2	Disability	+	2.11	0.00475	0.109
3	Old Age	+	2.26	0.00442	0.101
4	Family/children	+	2.38	0.00420	0.096
5	Unemployment/unemployment rate	+	2.45	0.00409	0.093
6	Other functions (survivors, housing, social exclusion)	+	2.45	0.00408	0.093
7	At-risk-of-poverty rate after social transfers	-	2.48	0.00403	0.092
8	Improvement in the rate of at-risk-of-poverty through transfers	+	1.87	0.00535	0.122
9	Relative median at-risk-of-poverty gap	-	2.64	0.00379	0.087
10	Total public expenditure on education as a percentage of GDP	+	1.98	0.00506	0.116
	Total			0.04376	1.000

S: Eurostat, WIFO calculations.

Table 14: Point value and range of the five area indices (unsorted)

Country	Overall Labour Market Performance		Orientation towards Integration		Equity of Access and Continuity		Distribution of Earnings		Distribution by the Welfare State	
	1		2		3		4		5	
	Point value	Rank	Point value	Rank	Point value	Rank	Point value	Rank	Point value	Rank
Belgium	6.4	12	7.3	6	5.7	10	10.0	1	7.8	7
Bulgaria	2.9	25	3.4	21	n.v.	n.v.	3.0	23	1.1	26
Czech Republic	6.5	10	4.6	14	4.5	12	4.8	18	4.3	17
Denmark	8.0	5	10.0	1	8.9	2	8.7	3	10.0	1
Germany	8.1	4	7.3	7	3.9	16	5.6	15	6.8	9
Estonia	6.9	8	4.7	13	n.v.	n.v.	2.4	24	3.0	23
Ireland	4.3	19	4.3	17	6.4	6	7.4	10	7.9	6
Greece	1.0	27	1.0	25	3.5	17	3.2	22	3.8	19
Spain	2.0	26	3.3	22	4.1	13	4.3	21	3.2	21
France	6.0	13	6.2	9	5.4	11	8.0	8	7.7	8
Italy	4.0	21	2.6	23	1.8	23	6.5	13	4.5	16
Cyprus	6.5	11	6.1	10	6.4	7	6.2	14	5.5	13
Latvia	3.0	24	4.3	18	2.9	19	1.4	26	1.6	25
Lithuania	5.1	16	4.4	15	4.0	15	2.0	25	3.4	20
Luxembourg	10.0	1	n.v.	n.v.	6.9	4	8.9	2	6.2	10
Hungary	3.1	23	3.7	19	1.9	22	4.8	17	5.8	12
Malta	4.8	18	n.v.	n.v.	2.0	21	8.4	6	3.9	18
Netherlands	7.8	7	8.9	3	6.5	5	7.5	9	8.4	4
Austria	8.8	3	8.8	4	4.1	14	6.6	12	8.0	5
Poland	4.9	17	5.3	12	3.3	18	4.4	20	2.9	24
Portugal	3.8	22	4.4	16	1.7	24	5.1	16	4.7	15
Romania	4.2	20	3.6	20	1.0	25	1.0	27	1.0	27
Slovenia	5.5	14	6.6	8	6.0	8	8.5	4	5.5	14
Slovakia	5.1	15	2.2	24	2.5	20	4.7	19	3.0	22
Finland	8.0	6	8.0	5	7.3	3	8.4	5	8.5	3
Sweden	9.6	2	9.2	2	10.0	1	8.2	7	8.5	2
United Kingdom	6.9	9	5.7	11	5.9	9	7.1	11	6.2	11

S: Eurostat, WIFO calculations. – Note: Abbreviation (n.a.) stands for, no calculation possible due to non-available data. Scale 1-10, whereby 1 = lowest value and 10 = highest value.

Table 15: Point value and ranking of the five area indices (sorted according to rank)

Overall Labour Market Performance			Orientation towards Integration			Equity of Access and Continuity			Distribution of Earnings			Distribution by the Welfare State		
1		2		3		4		5						
Rank	Country	Point value	Rank	Country	Point value	Rank	Country	Point value	Rank	Country	Point value	Rank	Country	Point value
1	LU	10.0	1	DK	10.0	1	SE	10.0	1	BE	10.0	1	DK	10.0
2	SE	9.6	2	SE	9.2	2	DK	8.9	2	LU	8.9	2	SE	8.5
3	AT	8.8	3	NL	8.9	3	FI	7.3	3	DK	8.7	3	FI	8.5
4	DE	8.1	4	AT	8.8	4	LU	6.9	4	SI	8.5	4	NL	8.4
5	DK	8.0	5	FI	8.0	5	NL	6.5	5	FI	8.4	5	AT	8.0
6	FI	8.0	6	BE	7.3	6	IE	6.4	6	MT	8.4	6	IE	7.9
7	NL	7.8	7	DE	7.3	7	CY	6.4	7	SE	8.2	7	BE	7.8
8	EE	6.9	8	SI	6.6	8	SI	6.0	8	FR	8.0	8	FR	7.7
9	UK	6.9	9	FR	6.2	9	UK	5.9	9	NL	7.5	9	DE	6.8
10	CZ	6.5	10	CY	6.1	10	BE	5.7	10	IE	7.4	10	LU	6.2
11	CY	6.5	11	UK	5.7	11	FR	5.4	11	UK	7.1	11	UK	6.2
12	BE	6.4	12	PL	5.3	12	CZ	4.5	12	AT	6.6	12	HU	5.8
13	FR	6.0	13	EE	4.7	13	ES	4.1	13	IT	6.5	13	CY	5.5
14	SI	5.5	14	CZ	4.6	14	AT	4.1	14	CY	6.2	14	SI	5.5
15	SK	5.1	15	LT	4.4	15	LT	4.0	15	DE	5.6	15	PT	4.7
16	LT	5.1	16	PT	4.4	16	DE	3.9	16	PT	5.1	16	IT	4.5
17	PL	4.9	17	IE	4.3	17	GR	3.5	17	HU	4.8	17	CZ	4.3
18	MT	4.8	18	LV	4.3	18	PL	3.3	18	CZ	4.8	18	MT	3.9
19	IE	4.3	19	HU	3.7	19	LV	2.9	19	SK	4.7	19	GR	3.8
20	RO	4.2	20	RO	3.6	20	SK	2.5	20	PL	4.4	20	LT	3.4
21	IT	4.0	21	BG	3.4	21	MT	2.0	21	ES	4.3	21	ES	3.2
22	PT	3.8	22	ES	3.3	22	HU	1.9	22	GR	3.2	22	SK	3.0
23	HU	3.1	23	IT	2.6	23	IT	1.8	23	BG	3.0	23	EE	3.0
24	LV	3.0	24	SK	2.2	24	PT	1.7	24	EE	2.4	24	PL	2.9
25	BG	2.9	25	GR	1.0	25	RO	1.0	25	LT	2.0	25	LV	1.6
26	ES	2.0	n.v.	LU	n.v.	n.v.	BG	n.v.	26	LV	1.4	26	BG	1.1
27	GR	1.0	n.v.	MT	n.v.	n.v.	EE	n.v.	27	RO	1.0	27	RO	1.0

S: Eurostat, WIFO calculations. – Note: Abbreviation (n.a.) stands for no calculation possible due to non-available data. Scale 1-10, whereby 1 = lowest value and 10 = highest value.

Appendix B – Definitions, sources and data availability

B.1 Definitions

B.1.1 Overall Labour Market Performance (1) and Orientation towards Integration (2)

Indicator	Description	Source
Employment rate (in %)	<p>The concept of employment rate is defined as the number of employed persons expressed as a ratio of the population in private households.</p> <p>According to the Eurostat definition, "employed persons are persons: from 15 years of age and over (from 16 in ES, UK and SE (1995-2001); 15-74 in DK, EE, HU, LV, FI and SE (from 2001); 16-74 in IS and NO) who during the reference week performed work, even for just one hour a week, for pay, profit or family gain or who were not at work but had a job or business from which they were temporarily absent because of, e.g. illness, holidays, industrial dispute or education and training."</p> <p>S: http://lepp.eurostat.ec.europa.eu/portal/page/portal/employment_unemployment_lfs/methodology/definitions.</p> <p>The Labour Market Monitor comprises employment rates for different age groups as listed below. The employment rate is calculated by dividing the number of employed persons of a given age group by the total population of the same age group.</p> <p>Area index 1: Employment rate (15-64 age group) Area index 2: Employment rate (25-44 age group) and employment rate for older workers (55-64 age group)</p>	EU-LFS
Employment gender gap (in percentage points)	<p>The term "employment gender gap" refers to the difference between male and female employment rates. For area index 2, this indicator has been calculated for both the 15-64 and the 25-44 age group.</p>	EU-LFS
Employment rate in full-time equivalents (in %)	<p>Total of hours worked divided by the average annual number of hours worked in full-time jobs, expressed as a percentage of the total population in the 15-64 age group.</p> <p>S: European Commission, Indicators for monitoring the Employment Guidelines including indicators for additional employment analysis, 2010 compendium.</p>	EU-LFS
Unemployment rate in %	<p>The unemployment rate is defined as the percentage of unemployed in the labour force. The concept of labour force refers to the total of employed and unemployed persons. Defined as unemployed are all people who</p> <ul style="list-style-type: none"> • were without work during the reference week • were available to start work within 2 weeks • have actively been seeking work in the past four weeks and people who have already found a job which they are to start at a later date 	EU-LFS

Indicator	Description	Source
<p>Long-term unemployment rate (in %)</p>	<p>S: Eurostat, Concepts and Definitions, http://ec.europa.eu/eurostat/ramon/nomenclatures/index.cfm?targetUrl=DSP_GLOSSARY_NOM_DTL_VIEW&strNom=CODED2&strLanguageCode=DE&initKey=16616635&RdoSearch=BEGIN&TxtSearch=arbeitslos&CboTheme=&IntCurr=enfPage=1.</p> <p>The Labour Market Monitor comprises the unemployment rates of different age groups as follows: Area index 1: Unemployment rate (15-64 age group). Area index 2: Youth unemployment rate (15-24 age group) and unemployment rate for older workers (55-64 age group).</p> <p>The unemployment rate is calculated by dividing the number of unemployed people of a given age group by the labour force of the same age group.</p>	EU-LFS
<p>Part-time employment, main reason: Could not find a full-time job (in %)</p>	<p>This indicator is defined as the number of people unemployed for more than 12 months as a ratio of the total number of unemployed. Persons defined as long-term unemployed have been without work for 12 months or longer, at least 15 years of age and do not live in collective households. They will be without work for the next two weeks, are in a position to start a new job in the next two weeks and are seeking work/have been intensively seeking work in the previous four weeks or are no longer looking for work as they have already found a job to start at a later date. The duration of unemployment is defined as the duration of the search for a job, or as the period of time since the last job was held.</p> <p>S: Eurostat, table: tsdsc330.</p> <p>Area index 2 comprises both the long-term unemployment rate of the 15-64 and the long-term unemployment rate of the 55-64 age group.</p>	EU-LFS
<p>Temporary employment, main reason: Could not find a permanent job (in %)</p>	<p>The definition of part-time as opposed to full-time employment is based on evaluation of spontaneous answers of the respondents surveyed (for exceptions, refer to source below). The indicator refers to a person's main job and provides information on the rate of respondents who are in part-time employment because they could not find a full-time job. A more precise differentiation between the terms part-time and full-time employment, cannot be established, as working times vary across Member States and economic sectors or activities.</p> <p>Note: In terms of Eurostat definitions, the expressions "could not find full-time employment" and "involuntary part-time employment" are considered equivalent (refer to ifsa_eppgai).</p> <p>S: Eurostat, http://epb.eurostat.ec.europa.eu/portal/page/portal/employment_unemployment_ifs/methodology/definitions.</p>	EU-LFS

Indicator	Description	Source
Employment growth compared to the previous year (In %)	<p>The “employment growth” indicator describes the change in percentage points of the total number of employed persons within the economic or geographic area of a country as compared with the previous year. The indicator is based on the European System of Accounts. Evaluations by gender are on the basis of Labour Force Survey distributions.</p> <p>S: Eurostat, table: tps00180.</p>	EU-LFS
Real GDP per capita (€ per inhabitant and index 2001=100)	<p>The GDP per capita is defined as the gross domestic product divided by the number of inhabitants for a specific year. It is frequently used as an indicator of a country’s economic well-being and, in particular, as a measure of the average real income of a country. It does, however, not constitute a complete measure of the economic well-being of a country, as it is, e.g. only based on market sector activities and does not take into account unpaid labour. Also, adverse effects of economic activities such as, e.g. environmental degradation are not taken into consideration. The real GDP per capita is based on rounded figures. Any differences between totals and percentage points showing in data tables are due to these approximations.</p> <p>S: Eurostat, table: tsdec100.</p>	NAS
Labour productivity per person employed (GDP in PPS per person employed in comparison to EU-27, EU-27=100)	<p>The gross domestic product (GDP) is a measure of the economic activity of a national economy. It is defined as the value of all newly created goods and services, minus the value of all preliminary expenditure on goods and services used. The “GDP in purchasing power standards (PPS) per employed person” is expressed as relative to the European Union (EU-27) average. If the index value of a country is larger than 100, the country has a GDP per employed person above EU average. If it is lower than 100, below EU average. The underlying figures are expressed as PPS, a single currency which balances price level differences between countries, thus allowing a meaningful GDP volume comparison. The concept of “persons employed” does not distinguish between full-time and part-time employment.</p> <p>S: Eurostat, table: tec00116.</p>	NAS
Public expenditure on active labour market policies as a percentage of GDP	<p>Expenditure on labour market policy (LMP) is restricted to public interventions which are expressly aimed at persons experiencing difficulties on the labour market: the unemployed, employees who are threatened with involuntary unemployment and people out of the labour force wishing to enter the labour market. The concept of public expenditure is categorized in three groups as follows:</p> <ul style="list-style-type: none"> • LMP services which cover the costs of public employment services (PES), including other publicly financed services for job seekers (category 1) • LMP measures which cover activation policies for the unemployed and other target groups: training and further training, job rotation and job sharing, employment incentives, supported employment and rehabilitation, direct creation of jobs, and start-up initiatives (categories 2-7) • LMP supports which provide income support for unemployed, especially unemployment benefits, and early retirement services (categories 8-9) <p>Incorporated into area index 2 are LMP measures categorized 2-7, in % of GDP. In addition, the indicator has been divided by the unemployment rate to denote the expenditure for active labour market policy in % of GDP per % unemployed. As such, it is also included in the calculation of the index</p> <p>S: Eurostat, table: tps00076.</p>	LMP



Indicator	Description	Source
Participants in active labour market policy measures as a percentage of the labour force	<p>The concept of labour market policy (LMP) measures refers to public labour market interventions where the main activity of participants is different from searching for a job and where participation, as a rule, results in a change of the labour market status. It primarily covers interventions aimed at providing temporary support to groups disadvantaged on the labour market, i.e. to the unemployed, to threatened employees and to persons out of the labour force. LMP measures are classified by the type of intervention and include the following categories: training and further training, job rotation and job sharing, employment incentives, supported employment and rehabilitation, direct creation of jobs, and start-up initiatives. Participants in LMP measures are defined as average annual stock, i.e. as the average number of persons taking part in measures at a certain point of time during the year. The average annual stock can also be interpreted in terms of person-years of a participation in intervention measures.</p> <p>For the calculation of area index 2, the participants taking part in intervention measures categorized 2-7, are divided by the labour force.</p> <p>Q: Eurostat, table: tps00079.</p>	LMP

B.1.2 Equity of Access and Continuity (3)

Indicator	Description	Source
Early leavers from education and training	<p>Defined by Eurostat as an "early leaver from education and training" is a person between 18 and 24 years of age who meets the following requirements:</p> <ul style="list-style-type: none"> his/her highest level of educational attainment is ISCED 0, 1, 2 or 3c he/she has reported not to have received any education or training in the four weeks preceding the survey <p>Whereas these variables constitute the numerator of the fraction, the denominator consists of the total population of the same age group, excluding those respondents who did not provide an answer to the questions of "highest level of education or training attained" and "participation in education and training". The values for both numerator and denominator are taken from the EU Labour Force Survey.</p> <p>S: Eurostat, table: tsdsc410.</p>	EU-LFS
Population with low educational attainment and population with tertiary educational attainment (in %)	<p>The indicator "population with low educational attainment (max secondary level I)" is defined as the percentage of the population between 25-64 or 25-34 years of age, respectively, with an educational level of 2 or lower, according to the international standard classification of education (ISCED). ISCED education levels 0-2 refer to pre-primary, primary and lower secondary level.</p> <p>S: Eurostat, Tabelle: tsdsc430.</p> <p>The indicator "population with tertiary educational attainment" is defined as the percentage of the population between 25-64 or 25-34 years of age, respectively, which has completed university or tertiary study programmes corresponding at least to ISCED education levels 5-6.</p> <p>S: Eurostat, table: t2020_41.</p>	EU-LFS
Life-long learning (Adult participation in education and training) (in %)	<p>The indicator "life-long learning (adult participation in education and training)" is defined as the percentage of the adult population (age group 25-64) participating in training and further training measures.</p> <p>The concept of "life-long learning" refers to persons between 25 and 64 years of age who reported to have participated in training or study measures within four weeks of taking the survey (numerator). The denominator consists of the overall population of the same age group and excludes those who did not respond to the question of "participated in training or studies". The values for both numerator and denominator are taken from the EU Labour Force Survey. The information provided refers to training and study measures in general whether or not relevant to the current or future employment of the people surveyed.</p> <p>S: Eurostat, table: tsdsc440.</p>	EU-LFS
Percentage of employees participating in continuing vocational training (in %)	<p>The indicator "percentage of employees participating in continuing vocational training" provides information on the percentage of employees participating in vocational further training courses in companies and businesses. The term refers to further training (courses or other forms of vocational further training) offered and financed, or partially financed, by the company or during paid working time.</p> <p>S: Statistics Austria, Standard documentation, metadata on European surveys on vocational training (CVTS3).</p>	CVTS3

Indicator	Description	Source
Inactive population in % of the total population	<p>The term of "inactive population" is used to denote persons out of the labour force according to the Labour Force Concept (LFC).</p> <p>Regarded as "inactive" are those who are not referred to as either unemployed or employed, i.e., for example, students, men and women in military or community service, pensioners, care givers to children or adults, homemakers.</p> <p>S: <i>Statistics Austria, Micro census data from 2004, Interviewer handbook incl. descriptions of characteristics of the LFS variables.</i></p>	EU-LFS
Inactive population, main reason for not seeking employment: Care responsibilities (in %)	<p>This indicator covers the percentage of persons between 15 and 64 of working age who are not searching for work because of care responsibilities. The Statistics Austria interviewer handbook lists the following reasons for not seeking work: retirement, education or training, other personal obligations such as taking care of house and family, care of children or adults, illness or disability, or the assumption that no suitable work would be available.</p> <p>S: <i>Statistics Austria, Micro census data from 2004, Interviewer handbook incl. descriptions of characteristics of the LFS variables.</i></p>	EU-LFS
Part-time employment, main reason: Care responsibilities (in %)	<p>This indicator is defined as the percentage of persons between 15 and 64 of working age who work part-time because of care responsibilities. The differentiation between part-time and full-time is based on an evaluation of spontaneous responses of the people surveyed. In this context, the Statistics Austria interviewer handbook covers questions as to whether people work part-time or full-time and as to the reasons why they work part-time: because of care obligations to children or adults, because of other personal or family-related reasons, because of education or (continuing vocational) training, because of illness or disability or other reasons, because they prefer to work part-time instead of full-time, because they have not been able to find full-time work.</p> <p>S: <i>Statistics Austria, Micro census data from 2004, Interviewer handbook incl. descriptions of characteristics of the LFS variables.</i></p>	EU-LFS

Indicator	Description	Source
Formal child care (according to duration) in % of all children in the same age group	<p>This indicator has been incorporated into area index 3 in terms of formal childcare provided to children younger than three years of age between 1 and 29 hours weekly and formal childcare provided to children younger than three years of age for 30 hours or more weekly (in % of all children in the same age group).</p> <p>Thereby, the concept of "formal childcare agreement" refers to the following four types of childcare and early education:</p> <ul style="list-style-type: none"> • pre-school education • compulsory school education • childcare provided by institutions other than schools or before/after school time • child day-care centres <p>It comprises all organized and regulatory systems of childcare, public as well as private. Moreover, in order for childcare to be classified as "formal", clearly defined patterns of quality have to be followed. This is why care provided by child minders, which is not characterized by formal structures between care provider and parents as described above (direct arrangement) does not constitute "formal childcare" under this definition. The concept of "duration" in the indicator description refers to the average number of hours childcare is provided in the course of a regular week.</p> <p>S: <i>Eurostat, table: tps00185.</i></p>	EU-SILC
Number of work-related accidents (with fatal outcomes)	<p>The indicator on the "number of work-related accidents with fatal outcomes" has been taken from the ESAW statistics records (European Statistics on Accidents at Work). ESAW deals with work-related accidents that result in more than three days of absence from work and fatal work-related accidents of which either the responsible social or private insurance has been notified. A fatal work-related accident is defined as an accident that leads to the death of the victim of the accident within one year.</p> <p>S: <i>European Commission, European Statistics on Accidents at Work (ESAW), Methodology, 2001 edition.</i></p>	ESAW
Healthy life years	<p>The structural indicators of "healthy life years at birth" and "healthy life years at the age of 65", also referred to as "disability-free life expectancy" (DFLE) indicators are calculated by gender. Providing a measure of the number of years a person can expect to live a healthy life at the time of his/her birth or at the age of 65 years, they serve as an indicator of health expectancy, with the concept of healthy condition being defined as the absence of limitations due to illness or disability.</p> <p>Incorporated into this index are mortality statistics from Eurostat's demographic database as well as data on the self-assessment of disability (EU-SILC).</p> <p>S: <i>Eurostat, table: tsdph100 and tsdph220, Europe in Numbers, Eurostat Annual Report 2010.</i></p>	HLY



Indicator	Description	Source
Self-perceived health (in %)	<p>The Labour Market Monitor covers three indicators of self-perceived health:</p> <ol style="list-style-type: none"> 1) The indicator of "self-perceived health of employed persons" provides insight into an employee's perception of his/her own health. Incorporated into the index is the percentage of respondents answering "good" or "very good" to the question as to their health perception. 2) The indicator "self-perceived limitations of employed persons" covers the extent to which, at least in the last six months, an employee has been affected in his/her daily activities due to health-related problems. Incorporated is the percentage of respondents answering "severe" or "some limitations" to the question of potential limitations as defined above. 3) The indicator of "persons with long-standing (chronic) illness or health problem" refers to all factors which have impaired the health of a respondent in the past over a longer period of time or which will probably impair him/her over a longer period of time in the future 	EU-SILC

S: Eurostat, *Europe in Numbers. Eurostat Annual Report 2010*.

B.1.3 Distribution of Earnings (4)

Indicator	Description	Source
Nominal wages per employee in PPS	<p>The indicator of "nominal wages per employee in PPS" is determined by dividing National Accounts gross wages and salaries (in million PPS, all NACE economic activities) by National Accounts employees. In this context, National Accounts System (NAS) calculations are not in terms of the place of residence of an employee but rather in terms of the place of production (concept of "domestic principle").</p> <p>As the term "compensation of employees", the concept of "gross wages and salaries" includes monetary rewards and in-kind payments. In contrast to the former, however, it does not include social contributions paid by the employer.¹</p> <p>S: Eurostat, table: tec00014.</p>	NAS
Compensation of employees	<p>Incorporated into the "compensation of employees" indicator are both "compensation of employees per capita in PPS" and "compensation of employees as a percentage of GDP".</p> <p>The indicator of "compensation of employees per capita in PPS" comprises National Accounts employee compensation (in million PPS) divided by the number of National Accounts employees. In this context, National Accounts System (NAS) calculations are not in terms of the place of residence of an employee but rather in terms of the place of production (concept of "domestic principle").</p> <p>The term "compensation of employees" includes all monetary rewards and in-kind payments to employees provided by an employer as compensation for the work performed. In particular, it also includes social contributions paid by the employer.</p> <p>Thus, it is divided into gross wages and salaries (both in the form of monetary rewards and in the form of in-kind payments) and into social contributions paid by the employer (both actual and imputed)</p> <p>S: Eurostat, table: tec00013 and http://circa.europa.eu/irc/dsis/nafaccount/info/datal/esa95/de/esa00155.htm, Statistics Austria (2010A), Standard documentation, metadata, (definitions, explanations, methods, quality) on the national accounts, NAS – annual calculations, Vienna, retrieved 08.03.2010.</p>	NAS

¹ Gross wages and salaries in the form of cash benefits include all paid social contributions, income tax, etc. paid by the employee, even if these are retained by the employer and paid directly to the social protection system, tax authorities, etc. Gross wages and salaries in the form of allowance in kind includes goods, services and or types of services offered for free, or at a reduced price, provided by the employer and which can be used and, according to the employer, are deemed sufficient to achieve satisfaction for themselves or the satisfaction of other members of their household. These goods, services and other types of services do not serve primarily the production process of the employer. For the employee, the wages and salaries in the form of allowances in kind comprise an additional income which they would otherwise have had to pay the market price for, if they had purchased these services themselves.

S: Eurostat, <http://circa.europa.eu/irc/dsis/nafaccount/info/datal/esa95/de/esa00157.htm>.

Indicator	Description	Source
Inequality of income distribution (income quintile share ratio)	<p>As defined by Eurostat, "the income quintile share ratio or the S80/S20 ratio is a measure of the inequality of income distribution. It is calculated as the ratio of total income received by the 20 % of the population with the highest income (the top quintile) to that received by the 20 % of the population with the lowest income (the bottom quintile)". The Labour Market Monitor analyses this ratio for each Member State, which provides a tool for measuring changes in the top and bottom quintiles.</p> <p>S: Eurostat, table: tessi180 and tsdsc260. http://epp.eurostat.ec.europa.eu/statistics_explained/index.php/Glossary:S80/S20_ratio.</p>	EU-SILC
Taxes on labour (in %)	<p>The indicator taxes on labour is expressed as a percentage of total taxation. According to the Eurostat definition "total tax revenue is the income a government generates through the taxation of the people. It includes taxes on production and imports, current tax on income and wealth, capital gains tax, and social contributions".</p> <p>Taxes on labour are "taxes directly linked to wages and mostly withheld at source, paid by employees and employers, including compulsory social contribution and on non-employed labour income."</p> <p>S: European Commission, <i>Taxation Trends, 2010</i>. http://epp.eurostat.ec.europa.eu/statistics_explained/index.php/Glossary:Tax_revenue.</p>	Taxation Trends, 2010
Proportion of low wage earners (in % of full-time employees)	<p>The proportion of low-wage earners is calculated by dividing the number of low-wage earners by the number of full-time employees. The indicator comprises the annual earnings of full-time employees. A full-time employee is defined as a low-wage employee if his/her annual gross income is less than two-thirds of the annual (full-time) median gross income. Data refer to enterprises with 10 employees or more and to NACE Rev. 2 sections B to S excluding O.</p> <p>S: Eurostat, <i>Statistics in focus, 3/2010</i>.</p>	SES
„Working Poor“ (in %)	<p>The "working poor" indicator refers to the at-risk-of-poverty rate of employed persons. It is defined as the percentage of employed persons of 18 years or older "with an equivalised disposable income (after social transfer) below the at-risk-of-poverty threshold, which is set at 60 % of the national available median equivalent income after social transfers".</p> <p>S: Eurostat, table: tsdsc320. http://epp.eurostat.ec.europa.eu/statistics_explained/index.php/Glossary:At-risk-of-poverty_rate.</p>	EU-SILC
Gender Pay Gap (in %)	<p>The concept of "gender pay gap" denotes the gender-specific earnings gap in unadjusted form. It is defined as the difference between average gross hourly earnings of male paid employees and female paid employees, expressed as a percentage of average gross hourly earnings of male paid employees. Reference population: all paid employees in enterprises with 10 employees or more in NACE Rev. 2 aggregates B to S (excluding O) – prior to 2008: NACE Rev. 1.1 aggregates C to O (excl. L).</p> <p>S: Eurostat, table: tsdsc340.</p>	SES

B.1.4 Distribution by the Welfare State (5)

Indicator	Description	Source
Social protection benefits by function in % of GDP	<p>The European System of Integrated Social Protection Statistics (ESSPROS), a data and information base of fundamental importance to the field of social policy, provides for the following general definition of the concept: "Social protection comprises all interventions from public or private bodies intended to relieve households and individuals of the burden of a defined set of risks or needs, provided that there is neither a simultaneous reciprocal nor an individual arrangement involved."</p> <p>ESSPROS refers to "social benefits" as "transfers to households, in cash or in kind intended to relieve them from the financial burden of a number of risks or needs" and distinguishes the following eight functions of social protection:</p> <ul style="list-style-type: none"> • Sickness/health care • Disability • Old Age • Survivors • Family/children • Unemployment • Housing • Social exclusion not elsewhere classified <p>Social protection benefits are expressed as a percentage of the GDP. Care has to be taken not to confuse the concept of "social protection benefits" with concept of "social rate", which refers to "social expenditure as a percentage of GDP". The term "social expenditure" comprises social services and, in contrast to the term "social protection benefits", also administrative costs and expenditure not otherwise classified, i.e. the latter two are not included in the concept of "social protection benefits". Moreover, it is also important to note that education is not regarded as social protection and therefore not considered an ESSPROS function.</p> <p>ESSPROS is compiled annually in all EU Member States.</p>	ESSPROS
At-risk-of-poverty rate after social transfers (in %)	<p>The at-risk-of-poverty rate is defined as the percentage of persons living in a household with an equivalised disposable income below the at-risk-of-poverty threshold, which is set at 60 % of the national equivalised disposable median income (after social contributions and pensions). "Equivalised income" is calculated by dividing the total income of a household by a factor which is determined by assigning the following weights to its components: first adult – 1.0, all other members of the household of 14 years and older – 0.5, members of the household younger than 14 – 0.3.</p>	EU-SILC

S: Eurostat, table, tess010, Press release 21/2012.



Indicator	Description	Source
Improvement in the at-risk-of-poverty rate through social transfers (in percentage points)	For this indicator, the at-risk-of-poverty rate after social transfer is subtracted from the at-risk-of-poverty rate before social transfer, with pensions not being included in the at-risk-of-poverty rate before social transfer.	EU-SILC
Relative median at-risk-of-poverty gap (in %)	The relative median of poverty is defined as the difference between the at-risk-of-poverty threshold (which is set at 60 % of the median national equivalised disposable income after social transfer) and the median equivalised net income of persons below the at-risk-of-poverty threshold. The median of the at-risk-of-poverty gap is expressed as a percentage of the at-risk-of-poverty threshold. S: <i>Eurostat, table: tsdsc250.</i>	EU-SILC
Total public expenditure on education (in % of GDP)	Educational systems tend to be financed by public sector spending. The indicator of "total public expenditure on education" constitutes a measure of the total public education expenditure expressed as a percentage of GDP. It covers both direct government spending on educational institutions by bearing the day-to-day and capital expenses (and indirect government spending by supporting students and their families with grants and loans as well as subsidizing educational activities of private companies or non-profit organizations). S: <i>Eurostat, table: tsdsc510.</i>	UOE

B.2 Used data sources

Labour Force Survey EU (EU-LFS)

The European Union's Labour Force Survey (LFS) is the main data source for more than 20 indicators incorporated into the first three area indices. In Austria, the Labour Force Survey provides central data on employment, unemployment, inactivity and education. The survey is based on random sampling and carried out since 1995 by Statistik Austria within the scope of a special microcensus programme. This is carried out by means of population surveys carried out in private households.¹ The basis for the international comparability of the data is defining criteria, based on the guidelines issued by the International Labour Organisation. The questionnaire also includes additional background questions such as, for example, the reason behind part-time employment or temporary employment. This data can be combined with socio-demographic variables (e.g. age groups, gender, etc.). The indicators "early leavers from education and training", "population according to educational qualification" and "adult participation in training and further training" is also based on the results of the labour force survey and are incorporated into the area index 3 ("equity of access and continuity").

Labour market policy (LMP)

The data on the Labour Market Policy (LMP) provides statistics on the labour market policy approaches in the Member States. This data is compiled annually based on administrative sources.² The target groups for intervention are persons who face disadvantages in integrating into the employment system. This covers not only the unemployed but also, for example, those who are currently employed but are in danger of involuntary unemployment or inactive persons who would like to enter the labour market but who are disadvantaged in one form or another (European Commission, 2006). Information on public expenditure for (active) labour market policy and the numbers of participants taking part in (active) labour market policy measures is taken from the LMP database, and is incorporated into the area index 2 ("orientation towards integration").

¹ Institutional households (e.g. nursing homes and boarding schools etc.) are not taken into account. The main target group surveyed are persons starting from 15 years of age (Statistik Austria, 2004).

²According to Eurostat, there are currently no legal requirements for the creation of labour market policy statistics. The provision of data is based on a voluntary basis (S: Eurostat, http://epp.eurostat.ec.europa.eu/portal/page/portal/labour_market/labour_market_policy.)

Annual national accounts (including GDP)

The National Account Systems (NAS) plays an important role in the present Labour Market Monitor as data from the NAS flows into two indices (area index 1 – “overall labour market performance” and area index 4 – “distribution of earnings”). Data for the national account system is collected according to the European System of National Accounts 1995 (ESA95). Every Member State compiles its own national account systems (Statistik Austria in Austria). Eurostat aggregates the NAS of all Member States with the ESA95 transmission programme data set. The annual national account system is a coherent and consistent system of macroeconomic indicators. A wealth of data from various different sources goes into the NAS annual calculations. Thereby, a basic differentiation should be made between the sources of economic statistics – in Austria, they are mostly collected by Statistik Austria – and administrative data (Statistik Austria, 2010A). The gross domestic product is considered to be the most important parameter of the NAS and is incorporated into the area index 1 – “overall labour market performance”. Further indicators are labour productivity, employment growth (also area index 1) and also employee compensation and gross wages and salaries (area index 4).

Continuing vocational training (2005, CVTS3)

The key figure “percentage of the employees participating in continuing vocational training” in area index 3 (“equity of access and continuity”) originates from the European survey on continuing vocational training. This takes place every five years based on a European legally binding basis, applicable to all EU Member States. The third and most recent survey was carried out in 2005.³ The survey takes place on the basis of a random sample of companies in the production and service sector with a minimum of ten employees (Statistik Austria, 2009B). In addition to this information on the participants in continuing vocational training, Eurostat also provides information on the companies with and without offers for vocational training, the costs of continuing training, the hours spent and the initial vocational training.

³ No newer version of CVTS3 was available at the point in time of the creation of the Labour Market Monitor update in 2011. Results for the reporting year 2010 (CVTS4) are not expected before 2012, according to the German Federal Institute for Vocational Education and Training (BIBB).

EU-Statistics on Income and Living Conditions (EU-SILC) and Structural indicators on health

EU-SILC is a Europe-wide annual household survey, which serves as the basis for comparable data on income, poverty and social exclusion within the Union. The EU-SILC questionnaire also contains questions on health. The actual method of collecting data remains a matter for the individual countries. In Austria, the data is collected through personal surveying of households by means of Computer Assisted Telephone Interviewing (CATI) and Computer Assisted Personal Interviewing (CAPI) surveys carried out by Statistik Austria (Statistik Austria, 2010B).

Data from the EU-SILC survey are included in the area indices 3 ("equity of access and continuity"), 4 ("distribution of earnings") and 5 ("distribution welfare state"). The related indicators are "child care", "employed persons with a disability", "self-perceived health of employed person" and "self-perceived work restrictions of the employed" (area index 3), "inequality of income distribution" and "working poor" (area index 4) and "at-risk-of-poverty rate" and "at-risk-of-poverty gap" (area index 5).

HLY (healthy life years)

The indicator "healthy life years" (HLY) is made up from mortality statistics from Eurostat's demographic database, on the one hand and from self-assessments on limitations and disabilities from the EU-SILC, on the other. The indicator describes the healthy years from birth or respectively from the age of 65 years, each separated according to men and women in area index 3 ("equity of access and continuity").

European Statistics on Accidents at Work (ESAW)

Area index 3 "equity of access and continuity" contains the indicator "number of fatal work-related accidents". The data source for this indicator is ESAW, which records both work-related accidents resulting in an interruption of work of more than three days and fatal work-related work accidents.⁴ Due to data limitations, only the indicator "number of fatal work-related accidents" is included in the index.

⁴ http://epp.eurostat.ec.europa.eu/portal/page/portal/health/health_safety_work/data.

Structure of Earnings Survey (SES)

The results of the Structure of Earnings Survey, which is carried out every four years, are available from Eurostat two years after the end of the reference year. Data from the SES is included in the area index 4 – (“distribution of earnings”) with the “rate of low wage earners” and the “gender pay gap”. The objective of the SES is to ascertain the EU-wide comparable data on the level and distribution of earnings. Correspondingly, the data is also based on unified definitions and makes it possible to carry out reliable comparisons between the Member States. Data on the earnings of employed persons in companies of ten or more employees in the production sector and private service area are collected (*Statistik Austria, 2009A*). Eurostat provides detailed information on the gross hourly, monthly and annual earnings, paid leave and annual holiday days. This data makes it possible, among other things, to analyse the structure and distribution of earnings according to the sector, profession, educational qualification, age and gender.

Taxation trends in the European Union (Eurostat and DG TAXUD)

Area index 4 – “distribution of earnings” contains an indicator on the taxes on labour as a factor of production. The data is taken from the publication “Taxation Trends in the European Union (2010)”, which is the result of cooperation between Eurostat and the Directorate-General for Taxation and Customs Union (DG TAXUD). The publication contains detailed statistical and economic analyses on the tax systems of the Member States of the EU and Iceland and Norway.

European System of Integrated Social Protection Statistics (ESSPROS)

The expenditure and income in the area of social protection within the EU are recorded annually by means of a harmonised methodology. This is intended to ensure a comprehensive and coherent description of the level of social protection within the Member States. The expenditure for social protection is differentiated according to eight functions or risks. These define the purpose of the provided funds and services; the following functions are referred to: sickness/health care; disability; old age; family/children; survivors; unemployment; housing and social exclusion (*European Commission, 2008, Statistik Austria, 2010C*). In area index 5 (“distribution welfare state”) all functions are included, whereby the three risks, survivors, housing and social exclusion, are combined together as “other”.

In Austria, Statistik Austria has taken over the task of calculating the ESSPROS data on behalf of the Federal Ministry for Labour, Health and Social Welfare (BMASK) since the year 2000. This data is available for download each year on the website of the European Statistical Office.

UNESCO, OECD, EUROSTAT (database on education statistics)

The expenditure on public and private education, among other things, within the formal education system, is available within the scope of the UOE education statistics. The indicator, total public expenditure for education (in % of GDP), is incorporated into the area index “distribution welfare state” (5). The UOE questionnaire is used collectively by the three organisations, UNESCO, OECD and Eurostat, in order to generate internationally comparable data from administrative sources on an annual basis.

B.3 Data availability

Table 16: Data availability for the indicators of area index 1: Overall Labour Market Performance
Updated August/September 2012

No.	Indicators	Source (Eurostat online data code)	Year	Countries																										
				BE	BG	CZ	DK	DE	EE	IE	GR	ES	FR	IT	CY	LV	LT	LU	HU	MT	NL	AT	PL	PT	RO	SI	SK	FI	SE	UK
1	Employment rate (15-64 years old)	lfsa_ergan	2009 2010 2011																											
2	Employment rate in full-time equivalents	Eurostat (Sonder- auswertung)	2009 2010 2011																											
3	Employment growth compared to the previous year	lfsi_grt_a	2009 2010 2011																											
4	Unemployment rate (15-64 years old)	lfsa_urgan	2009 2010 2011																											
5	Real GDP per capita (Euro per inhabitant)	nama_aux_gp	2009 2010 2011																											
6	Real GDP per capita (index 2001 = 100)	nama_aux_gp	2009 2010 2011																											
7	Labour productivity per person employed	nama_aux_lp	2009 2010 2011																											

S: Eurostat, WIFO. – Note: Data available are highlighted in light grey, data not available are highlighted in dark grey.

Table 17: Data availability for the indicators of area index 2: Orientation towards Integration
Updated July 2012

No.	Indicators	Source (Eurostat online data code)	Year	Countries																											
				BE	BG	CZ	DK	DE	EE	IE	GR	ES	FR	IT	CY	LV	LT	LU	HU	MT	NL	AT	PL	PT	RO	SI	SK	FI	SE	UK	
1	Employment rate (25-44 years old)	lfsa_pganws	2009																												
			2010																												
			2011																												
2	Employment gender gap: Difference between male female employment rates (25-44 years old)	lfsa_pganws	2009																												
			2010																												
			2011																												
3	Employment rate (55-64 years old)	lfsa_ergan	2009																												
			2010																												
			2011																												
4	Part-time employment, main reason: Could not find full-time job	lfsa_epgar	2009																												
			2010																												
			2011																												
5	Temporary employment, main reason: Could not find permanent job	lfsa_etgar	2009																												
			2010																												
			2011																												
6	Employment gender gap: Difference between male female employment rates (15-64 years old)	lfsa_ergan	2009																												
			2010																												
			2011																												
7	Unemployment rate (15-24 years old)	lfsa_urgan	2009																												
			2010																												
			2011																												
8	Unemployment rate (55-64 years old)	lfsa_urgan	2009																												
			2010																												
			2011																												

Continued Table 17: Data availability for the indicators of area index 2: Orientation towards Integration

No.	Indicators	Source (Eurostat online data code)	Year	Countries																											
				BE	BG	CZ	DK	DE	EE	IE	GR	ES	FR	IT	CY	LV	LT	LU	HU	MT	NL	AT	PL	PT	RO	SI	SK	FI	SE	UK	
9	Long-term unemployment rate (15-64 years old)	lfsa_upgal	2009																												
			2010																												
			2011																												
10	Long-term unemployment rate (55-64 years old)	lfsa_upgal	2009																												
			2010																												
			2011																												
11	Public expenditure on (active) labour market policies as a percentage of GDP	Imp_expsumm	2009																												
			2010																												
			2011																												
12	Public expenditure on labour market policies as a percentage of GDP per % unemployed person	Imp_expsumm lfsa_urgan	2009																												
			2010																												
			2011																												
13	Participants in active labour market policy measures/interventions as a percentage of the labour force	Imp_partsumm	2009																												
			2010																												
			2011																												

S: Eurostat, WIFO. – Note: Data available are highlighted in light grey, data not available are highlighted in dark grey.

Table 18: Data availability for the indicators of area index 3: Equity of Access and Continuity
Updated August 2012

No.	Indicators	Source (Eurostat online data code)	Year	Countries																											
				BE	BG	CZ	DK	DE	EE	IE	GR	ES	FR	IT	CY	LV	LT	LU	HU	MT	NL	AT	PL	PT	RO	SI	SK	FI	SE	UK	
1	Early leavers from education and training	edat_ifse_14	2009																												
			2010																												
			2011																												
2	Population (25-64 years old) with low educational attainment (max. secondary level I)	edat_ifs_9903	2009																												
			2010																												
			2011																												
3	Population (25-34 years old), with low educational attainment (max. secondary level I)	edat_ifs_9903	2009																												
			2010																												
			2011																												
4	Population (25-64 years old), with tertiary educational attainment	edat_ifs_9903	2009																												
			2010																												
			2011																												
5	Population (25-34 years old), with tertiary educational attainment	edat_ifs_9903	2009																												
			2010																												
			2011																												
6	Life-long learning (Adult participation (25-64 years) in education and training)	trng_ifs_01/ tsiem080	2009																												
			2010																												
			2011																												
7	Percentage of employees participating in continuing vocational training	trng_cvts3_41	2005																												
8	Inactive population (Out of labour force): Main reason care responsibilities	fsa_igar	2009																												
			2010																												
			2011																												
9	Part-time employment, main reason: Care responsibilities	fsa_epgar	2009																												
			2010																												
			2011																												
10	Inactive population (Out of labour force)	fsa_ipga	2009																												
			2010																												
			2011																												

Continued Table 18: Data availability for the indicators of area index 3: Equity of Access and Continuity

No.	Indicators	Source (Eurostat online data code)	Year	Countries																											
				BE	BG	CZ	DK	DE	EE	IE	GR	ES	FR	IT	CY	LV	LT	LU	HU	MT	NL	AT	PL	PT	IR	SI	SK	FI	SE	UK	
11	Formal child care (children less than three years) from 1 hour weekly	ilc_caihdforma	2009																												
			2010																												
			2011																												
12	Formal child care (children less than three years) 30 hours or more weekly	ilc_caihdforma	2009																												
			2010																												
			2011																												
13	Number of fatal work-related accidents	hsw_aw_nnas / hsw_mi01	2009																												
			2010																												
			2011																												
14	Healthy life years at birth – women	hlth_hlye	2009																												
			2010																												
			2011																												
15	Healthy life years at birth – men	hlth_hlye	2009																												
			2010																												
			2011																												
16	Healthy life years at the age of 65 – women	hlth_hlye	2009																												
			2010																												
			2011																												
17	Healthy life years at the age of 65 – men	hlth_hlye	2009																												
			2010																												
			2011																												
18	Employed persons with disabilities	hlth_silc_04	2009																												
			2010																												
			2011																												
19	Self-perceived limitations of employed persons (severe + some limitations)	hlth_silc_06	2009																												
			2010																												
			2011																												
20	Self-perceived health of employed persons (very good + good)	hlth_silc_01	2009																												
			2010																												
			2011																												

S: Eurostat, WIFO. – Note: Data available are highlighted in light grey, data not available are highlighted in dark grey.

Table 19: Data availability for the indicators of area index 4: Distribution of Earnings
Updated August/October 2012

No.	Indicators	Source (Eurostat online data code)	Year	Countries																											
				BE	BG	CZ	DK	DE	EE	IE	GR	ES	FR	IT	CY	LV	LT	LU	HU	MT	NL	AT	PL	PT	RO	SI	SK	FI	SE	UK	
1	Nominal wages per employee in PPS	nama_nace10/e	2009																												
			2010																												
			2011																												
2	Compensation of employees per capita in PPS	nama_nace10/e	2009																												
			2010																												
			2011																												
3	Compensation of employees as a percentage of GDP	nama_gdp_c	2009																												
			2010																												
			2011																												
4	Inequality of income distribution – income quintile share ratio	ilc_d11	2009																												
			2010																												
			2011																												
5	Taxes on labour as a percentage of total taxation	EU: Taxation Trends	2009																												
			2010																												
			2011																												
6	Working poor	ilc_iw01	2009																												
			2010																												
			2011																												
7	Proportion of low wage earners (full-time employees)	earn_ses10_aec1	2010																												
8	Gender Pay Gap	earn_gr_gpg12	2009																												
			2010																												
			2011																												

S: Eurostat, WIFO. – Note: Data available are highlighted in light grey, data not available are highlighted in dark grey.

Table 20: Data availability for the indicators of area index 5: Distribution by the Welfare State
Updated October 2012

No.	Indicators	Source (Eurostat online data code)	Year	Countries																											
				BE	BG	CZ	DK	DE	EE	IE	GR	ES	FR	IT	CY	LV	LT	LU	HU	MT	NL	AT	PL	PT	RO	SI	SK	FI	SE	UK	
1	Social protection benefits as a percentage of GDP: Sickness/health care	spr_exp_gdp	2009																												
			2010																												
			2011																												
2	Social protection benefits as a percentage of GDP: Disability	spr_exp_gdp	2009																												
			2010																												
			2011																												
3	Social protection benefits as a percentage of GDP: Old Age	spr_exp_gdp	2009																												
			2010																												
			2011																												
4	Social protection benefits as a percentage of GDP: Family/children	spr_exp_gdp	2009																												
			2010																												
			2011																												
5	Social protection benefits as a percentage of GDP: Unemployment/unemployment rate	spr_exp_gdp/it sa_urgan	2009																												
			2010																												
			2011																												
6	Social protection benefits as a percentage of GDP: Other functions (survivors, housing, social exclusion)	spr_exp_gdp	2009																												
			2010																												
			2011																												
7	At-risk-of-poverty rate after social transfers	ilc_l102	2009																												
			2010																												
			2011																												
8	Improvement in the rate of at-risk-of-poverty through transfers	ilc_l10 - ilci02	2009																												
			2010																												
			2011																												
9	Relative median at-risk-of-poverty gap	ilc_l11	2009																												
			2010																												
			2011																												
10	Total public expenditure on education as a percent of GDP	educ_figdp	2009																												
			2010																												
			2011																												

S: Eurostat, WIFO. – Note: Data available are highlighted in light grey, data not available are highlighted in dark grey.



Appendix C – Sensitivity Analysis

The Labour Market Monitor report applies sensitivity analysis to test the robustness of its results and compare the performance of the index to alternative configurations. This chapter analyses the changes observed upon the modifications of our original model and presents the results by area index.

In addition to the original methodology described in the previous chapters (referred to as “baseline” or “main/original method” below), we performed the following analyses:

First we tested the robustness of the index by varying the time of reference (baseline method used to evaluate data from the previous year, referred to as V3 in Table 28) and by doing an analysis on the basis of scores achieved in the sub-indices (referred to as V2 in Table 28). The rankings obtained when computing these alternatives are then compared with the rankings obtained when applying the original methodology (baseline).

The indicator that serves as a measure of the changes observed in this context is the correlation coefficient, r . A strong correlation between the results of the original methodology (baseline) and the results obtained when an alternative analysis is performed, implies a high level of robustness and, hence a high correlation coefficient. A measure of 1 indicates the highest possible (positive) correlation.

Secondly, we excluded individual indicators (with not more than one indicator being excluded at a time) and observed potential changes to the rankings incurred as a consequence (detailed results for Austria by area index are in tables 22-26).

Finally, as the inclusion in area index 5 of expenditure-related indicators as percentage of GDP, i.e. “social protection benefits as percentage of GDP” and “total public expenditure on education as percentage of GDP”, has been frequently criticised, we performed a more extended sensitivity analysis of this area index to test the robustness of its results, excluding these expenditure-related indicators on social protection benefits and education.

Below is an overview of all analyses applied, providing reference to tables for detailed results.

Table 21: Overview of all analyses applied

Analysis/Method	Description	Abbreviation	Reference
Baseline	Complete indicator set	V1	Table 27
Sensitivity Correlation	Sub-indices	V2	Table 27
Sensitivity Correlation	Previous year	V3	Table 27
Sensitivity Exclusion	Exclusion, single indicator	None	Tables 21-25
Sensitivity Exclusion extended	Exclusion, joint indicators	None	Table 26

S: WIFO.

Key findings of sensitivity analysis

Testing the robustness of the index by varying the time of reference (baseline applied on data from previous year, V3 in table 27) and by referring to the sub-indices (V2 in table 27) yields the following results:

As can be seen in table 27, our findings indicate a strong correlation between the rankings obtained as a result of the baseline (V1) and the rankings obtained from both alternative methods V3 and V2. Depending on the area index, the correlation between the original method (V1) and (V2) lies between $r_{V1-V2} = .93$ and $r_{V1-V2} = .98$. Therefore it can be assumed that the ranking will remain robust to possible changes of the indicator weights. Also, a correlation between $r_{V1-V3} = .83$ and $r_{V1-V3} = .99$ between the original method (V1) and (V3) implies a relatively stable ranking from one year to the next.

A comparison of the rankings by method and index shows that Austria's position within the European Union changes only slightly, if at all, depending on the index analysed. As for the "overall labour market performance" index, Austria comes third in each of the three methods. As for the "orientation towards integration" index, it ranks third (V3) or fourth (main method V1 and alternative V2). By contrast, the Austrian ranking turns out to be more sensitive in the area of "equity of access and continuity": While Austria ranks 14th according to main method results and 19th according to alternative V3 (main method on basis of previous year), thus being classified as "lower middle", it would be categorized as "upper middle", coming in 12th, when calculating the measure on the basis of sub-indices (V2). In the "earnings distribution" index, Austria scores 12th (V1 and V3) or 14th (V2), assuming an "upper middle" position. And, finally, on the measure of social welfare and transfer, i.e. area index 5, Austria is ranked as either 5th (V1 and V3) or 7th (V2) among the top countries.

Altogether, the changes in ranks within the five dimensions are minor, which means that changes to the model impact only slightly on the ranking of the countries.

As for the exclusion of indicators, tables 22-26 present the results of the sensitivity analysis (by index) for Austria. If the exclusion of an indicator results in an improvement of the ranking, this is indicated by the plus sign (+). The minus sign (-) indicates a deterioration in the ranking following the exclusion of an indicator. If the exclusion of an indicator does not result in a change of the ranking, this is indicated by the number zero (0).

As can be seen from the tables, a reduction of the number of indicators leads only to minor changes in the rankings.

In area index 1, "overall labour market performance" Austria comes third (Table 22), with a robust result: Only the exclusion of the indicator "real GDP per capita" leads to an improvement in ranking by one place, i.e. second instead of third.

Table 22: Overall Labour Market Performance (1) – change in ranking position for Austria

			Austria: Rank 3	
Sub-areas	Exclusion of the indicator ...	R ¹⁾	Change in ranking	
Employment	• Employment rate (15-64 years old)	0.99	0	
	• Employment rate in full-time equivalents	0.97	0	
	• Employment growth compared to the previous year	0.97	0	
Unemployment	• Unemployment rate (15-64 years old)	0.99	0	
Economic Growth and Productivity	• Real GDP per capita (€ per inhabitant)	0.98	1	
	• Real GDP per capita (index 2001 = 100)	0.95	0	
	• Labour productivity per person employed	0.97	0	

S: Eurostat, WIFO calculations. – 1) Correlation coefficient indicating correlation between main method (complete indicator set) and main method excluding a single indicator.

On the measure of “orientation towards integration”, i.e. area index 2, Austria comes fourth according to main method results (Table 23). Altogether, the index is a composite of 13 individual indicators, three of which react to modifications of the model: Whereas the exclusion of the indicator “temporary employment, main reason: could not find a permanent employment)” brings about a loss of one rank position, the exclusion of either the employment rate for older workers (rank 2 instead of 4) or the long-term unemployment for older workers (rank 3 instead of 4) leads to improvements as indicated in brackets.

Table 23: Orientation towards Integration (2) – change in ranking position for Austria

			Austria: Rank 4	
Sub-areas	Exclusion of the indicator ...	R ¹⁾	Change in ranking	
Employment	• Employment rate (25-44 years old)	0.98	0	
	• Employment gender gap: Difference between male and female employment rates (25-44 years old)	0.99	0	
	• Employment rate (55-64 years old)	0.99	2	
	• Part-time employment, main reason: Could not find a full-time job	0.98	0	
	• Temporary employment, main reason: Could not find a permanent job	0.98	-1	
	• Employment gender gap: Difference between male and female employment rates (15-64 years old)	0.99	0	
Unemployment	• Unemployment rate (15-24 years old)	0.99	0	
	• Unemployment rate (55-64 years old)	0.98	0	
	• Long-term unemployment rate (15-64 years old)	0.99	0	
	• Long-term unemployment rate (55-64 years old)	0.98	1	
Labour Market Policy	• Public expenditure on (active) labour market policies as a percentage of GDP	0.99	0	
	• Public expenditure on labour market policies as a percentage of GDP per % unemployed person	1.00	0	
	• Participants in active labour market policy measures/interventions as a percentage of the labour force	0.99	0	

S: Eurostat, WIFO calculations. – 1) Correlation coefficient indicating correlation between main method (complete indicator set) and main method excluding a single indicator.

On the measure of “equity of access and continuity”, i.e. in area index 3, Austria comes 14th among the Member States of the European Union (Table 24). This measure is an aggregate of 20 indicators, half of which have shown to respond to modifications of the model.

Table 24: Equity of Access and Continuity (3) – change in ranking position for Austria

			Austria: Rank 14	
Sub-areas	Exclusion of the indicator ...	R¹⁾	Change in ranking	
Education	• Early leavers from education and training	0.99	0	
	• Population (25-64 years old) with low educational attainment (max. secondary level I)	0.99	0	
	• Population (25-34 years old), with low educational attainment (max. secondary level I)	0.99	0	
	• Population (25-64 years old), with tertiary educational attainment	1.00	1	
	• Population (25-34 years old), with tertiary educational attainment	0.99	1	
	• Life-long learning (Adult participation (25-64 years) in education and training)	0.99	-1	
	• Percentage of employees participating in continuing vocational training	0.99	0	
Exclusion	• Inactive population (Out of labour force): Main reason care responsibilities	0.99	0	
	• Part-time employment, main reason: Care responsibilities	0.99	2	
	• Inactive population (Out of labour force)	1.00	-1	
Childcare	• Formal child care (children less than three years) from 1 to 29 hours weekly	0.99	0	
	• Formal child care (children less than three years) 30 hours or more weekly	1.00	1	
Health	• Number of fatal work-related accidents	0.98	-1	
	• Healthy life years at birth – women	0.99	1	
	• Healthy life years at birth – men	0.99	0	
	• Healthy life years at the age of 65 – women	0.99	0	
	• Healthy life years at the age of 65 – men	0.99	0	
	• Employed persons with disabilities	0.99	-1	
	• Self-perceived limitations of employed persons (severe + some limitations)	0.99	-1	
	• Self-perceived health of employed persons (very good + good)	0.99	0	

S: Eurostat, WIFO calculations. – ¹⁾ Correlation coefficient indicating correlation between main method (complete indicator set) and main method excluding a single indicator.

The exclusion of the following indicators leads to a deterioration of the relative position of Austria, i.e. to the loss of one rank, causing Austria to rank 15th instead of 14th:

- Indicator 6: “Life-long learning (adult participation (25-64 years) in education and training)”
- Indicator 10: “inactive population” (out of labour force)
- Indicator 13: “number of fatal work-related accidents”
- Indicator 18: “employed persons with disabilities”
- Indicator 20: “self-perceived health of employed persons”

By contrast, the exclusion of one of the following indicators as listed below causes Austria to rank higher by one place, i.e. 13th instead of 14th:

- Indicator 4: "population (age group 25-64) with tertiary educational attainment"
- Indicator 5: "population (age group 25-34) with tertiary educational attainment"
- Indicator 12: "formal child care (children younger than three years) 30 hours or more weekly"
- Indicator 14: "healthy life years at birth – women"

An improvement of two positions would be brought about by the exclusion of the indicator of "part-time employment, main reason: care responsibilities" – a measure on which Austria scores second-highest and therefore second last of all European countries.

In area index 4, "distribution of earnings", Austria's position is 12, with all, i.e. even slight modifications having an impact on Austria's ranking. An improvement of Austria's position can be brought about by excluding the indicators on which Austria performs poorly relative to other EU Member States. The exclusion of the indicator "taxes on labour in % of total taxation" leads to an improvement of the Austrian position by three ranks and the exclusion of the indicator "gender pay gap" to an improvement by two ranks.

However, the exclusion of one of the remaining six indicators leads Austria to perform worse relative to other Member States. Thus, exclusion of the indicator "compensation of employees per capita in PPS" results in the loss of two rank positions and the exclusion of the following indicators in the loss of one:

- Indicator 1: "nominal wages per employee in PPS"
- Indicator 3: "compensation of employees as a percentage of GDP"
- Indicator 4: "income quintile share ratio"
- Indicator 6: "working poor"
- Indicator 7: "proportion of low wage earners"

Table 25: Distribution of Earnings (4) – change in ranking position for Austria

Sub-areas	Exclusion of the indicator ...	R ¹⁾	Austria: Rank 12
			Change in ranking
Income/Salary	• Nominal wages per employee in PPS	0.98	-1
	• Compensation of employees per capita in PPS	0.98	-2
Distribution of Earnings	• Compensation of employees as a percentage of GDP	0.97	-1
	• Inequality of income distribution – income quintile share ratio	0.98	-1
	• Taxes on labour as a percentage of total taxation	0.97	3
Working Poor	• Working poor	0.98	-1
	• Proportion of low wage earners (full-time employees)	0.98	-1
Gender Pay Gap	• Gender pay gap	0.97	2

S: Eurostat, WIFO calculations. – 1) Correlation coefficient indicating correlation between main method (complete indicator set) and main method excluding a single indicator.

As for the social welfare index, i.e. index 5, Austria comes fifth in the table of EU states. The exclusion of the indicators “social protection benefits as a percentage of GDP” related to “sickness/health care” and “disability” would cause Austria to rise up one rank.

By contrast, if the indicator “social protection benefits as a percentage of GDP” related to “family/children” is not taken into account, Austria will drop one place. And, in case the following indicators are excluded, two places:

- Indicator 3 “social protection benefits as a percentage of GDP” related to “old age”
- Indicator 5 “social protection benefits as a percentage of GDP” related to “unemployment/unemployment rate”
- Indicator 7 “at-risk-of-poverty rate after social transfers”

Table 26: Distribution by the Welfare State (5) – change in ranking position for Austria

			Austria: Rank 5	
Sub-areas	Exclusion of the indicator ...	R¹⁾	Change in ranking	
Social Protection Benefits	Social protection benefits as a percentage of GDP (1-6)			
	• Sickness/health care	0.99	1	
	• Disability	0.98	1	
	• Old Age	0.98	-2	
	• Family/children	0.98	-1	
	• Unemployment/unemployment rate	0.99	-2	
	• Other functions (survivors, housing, social exclusion)	0.99	0	
At-Risk-Of-Poverty		0.99	-2	
	• At-risk-of-poverty rate after social transfers	0.99	0	
	• Improvement in the rate of at-risk-of-poverty through transfers	0.99	0	
Expenditure on Education	• Relative median at-risk-of-poverty gap	0.99	0	

S: Eurostat, WIFO calculations. – 1) Correlation coefficient indicating correlation between main method (complete indicator set) and main method excluding a single indicator.

Finally, the results of our extended sensitivity analysis based on the exclusion of indicators show that, when excluding all but the three “at-risk-of-poverty” indicators, Austria drops four places, from the 5th place among top countries to the 9th place, i.e. to the position classified as “upper middle“. When adding the indicator “social protection benefits as percentage of GDP” (“unemployment“) to the three indicators reflecting State intervention, Austria scores 6th. In contrast to other social protection benefits, those related to unemployment are not only measured as a percentage of GDP but statistically adjusted by dividing them by the unemployment rate to reflect the fact that social expenditure is traditionally higher in countries with higher unemployment rates. The results of the sensitivity analysis show that calculated in this way, Austria’s position would only change slightly, i.e. one rank, as compared to the results of the original model and methodology.

Table 27: Distribution by the Welfare State (5) – Extended sensitivity analysis

				Austria: Rank 5	
Method	Indicators	Indicators	R¹⁾	Change in ranking	
Extended Sensitivity Analysis 1	3 indicators	In the sub-area "at-risk-of-poverty"	0.82	-4	
Extended Sensitivity Analysis 2	4 indicators	In the sub-areas of "at-risk-of-poverty" and "social protection benefits as a percentage of GDP per % unemployed"	0.88	-1	

S: Eurostat, WIFO calculations. – ¹⁾ Correlation coefficient indicating correlation between main method and main method applied to reduced set of indicators.

How to read the table: When taking into account the complete set of 10 indicators, Austria ranks 5th in the table of EU countries. When reducing the index to an aggregate of the three at-risk-of-poverty indicators, Austria drops four places, from the 5th place to the 9th.

Table 28: Ranking position of all five area indices according to the calculation variations¹⁾

	Overall Labour Market Performance			Orientation towards Integration			Equity of Access and Continuity			Distribution of Earnings			Distribution by the Welfare State		
	V1	V2	V3	V1	V2	V3	V1	V2	V3	V1	V2	V3	V1	V2	V3
Belgium	12	9	10	6	6	7	10	9	9	1	1	1	7	5	6
Bulgaria	25	23	23	21	22	18	n.v.	n.v.	n.v.	23	22	24	26	26	25
Czech Republic	10	10	12	14	13	16	12	18	13	18	20	19	17	17	19
Denmark	5	7	5	1	1	1	2	1	2	3	5	7	1	1	1
Germany	4	5	6	7	7	6	16	14	16	15	17	15	9	10	10
Estonia	8	11	24	13	16	14	n.v.	n.v.	n.v.	24	25	23	23	19	22
Ireland	19	20	20	17	14	13	6	8	10	10	9	6	6	5	8
Greece	27	27	19	25	25	25	17	15	17	22	23	22	19	24	18
Spain	26	26	25	22	21	20	13	12	14	21	21	20	21	22	21
France	13	13	11	9	9	10	11	10	11	8	8	8	8	8	7
Italy	21	21	21	23	23	23	23	25	25	13	11	14	16	18	16
Cyprus	11	12	7	10	10	9	7	5	8	14	13	13	13	9	13
Latvia	24	22	27	18	18	17	19	16	19	26	27	26	25	25	26
Lithuania	16	18	26	15	19	19	15	13	15	25	24	27	20	20	24
Luxembourg	1	1	1	n.v.	n.v.	n.v.	4	6	4	2	4	2	10	15	12
Hungary	23	24	22	19	17	22	22	24	22	17	18	17	12	13	9
Malta	18	17	16	n.v.	n.v.	n.v.	21	22	21	6	3	4	18	16	17
Netherlands	7	4	4	3	2	2	5	3	5	9	10	10	4	4	3
Austria	3	3	3	4	4	3	14	19	12	12	14	12	5	7	5
Poland	17	16	14	12	11	12	18	20	18	20	16	21	24	21	20
Portugal	22	25	15	16	15	15	24	17	23	16	15	16	15	14	15
Romania	20	19	18	20	20	21	25	23	24	27	26	25	27	27	27
Slovenia	14	14	13	8	8	8	8	7	6	4	2	3	14	12	14
Slovakia	15	15	17	24	24	24	20	21	20	19	19	18	22	23	23
Finland	6	6	8	5	5	5	3	4	3	5	7	5	3	3	4
Sweden	2	2	2	2	3	4	1	2	1	7	6	9	2	2	2
United Kingdom	9	8	9	11	12	11	9	11	7	11	12	11	11	11	11
V1 – V2 ³⁾		0.98		0.98	0.98			0.93			0.98			0.97	
V1 – V3 ³⁾		0.83		0.97	0.97			0.99			0.98			0.98	
V2 – V3 ³⁾		0.85		0.97	0.97			0.93			0.97			0.96	

S: Eurostat, WIFO calculations. –¹⁾ calculation variations: V1 = variant 1: Complete indicator set, V2 = variant 2: Sub-indices, V3 = variant 3: previous year. ²⁾ n.a. means due to missing/not available data, the countries are not included in the index. ³⁾ V1 – V2, V1 – V3, V2 – V3: Provides the individual correlation between the variations.

Appendix Tables

In the following, both the raw data and also the ranking results are presented in table form. Upon request of the experts at the Chamber of Labour of Vienna, several indicators are included in the raw data according to gender, i.e. separately as men and women. Indicators represented according to gender will nevertheless be calculated in each area index simply as a "total".

Table 29: Raw data of the individual indicators of area index 1 – Overall Labour Market Performance, EU-27

	Employment						Unemployment			Economic growth and productivity		
	Employment rate (15-64 years old)			Employment rate in full-time equivalents			Unemployment rate (15-64 years old)			Real GDP per capita	Real GDP per capita	Labour productivity
	in %	Men	Women	in %	Men	Women	in %	Men	Women	€ per inhabitant	Index 2001=100	Index EU-27=100 ²⁾
	Total	in %	in %	Total	in %	in %	Total	in %	in %			
Belgium	61.9	67.1	56.7	56.8	66.2	47.7	7.2	7.2	7.2	29,900	109	127.3
Bulgaria	58.5	60.9	56.2	57.9	60.3	55.5	11.3	12.5	10.0	3,500 ³⁾	152 ³⁾	43.5
Czech Republic	65.7	74.0	57.2	64.7	73.8	55.3	6.8	5.9	8.0	11,500	134	73.5
Denmark	73.1	75.9	70.4	64.8	70.3	59.5	7.7	7.9	7.6	37,300	102	110.2
Germany	72.5	77.3	67.7	62.6	73.8	51.8	6.0	6.3	5.7	30,000	113	106.5
Estonia	65.1	67.7	62.8	63.2	67.0	59.7	12.8	13.4	12.1	9,100	147	67.6
Ireland	59.2	63.1	55.4	52.8	60.0	45.9	14.7	17.9	10.7	36,500	105	139.7
Greece	55.6	65.9	45.1	54.1	65.1	43.0	17.9	15.2	21.6	16,100	107	93.4
Spain	57.7	63.2	52.0	53.5	61.3	45.8	21.8	21.3	22.3	20,600	105	108.5
France	63.8	68.1	59.7	59.4	66.4	53.0	9.3	8.9	9.8	27,600	105	115.5
Italy	56.9	67.5	46.5	53.1	65.9	40.9	8.5	7.7	9.7	23,500	96	109.7
Cyprus	68.1	74.7	61.6	65.4	73.0	58.1	7.9	8.1	7.8	17,800	103	89.1
Latvia	61.8	62.9	60.8	60.3	61.8	58.9	15.6	17.9	13.3	6,400	160	62.7
Lithuania	60.7	60.9	60.5	59.8	60.8	58.9	15.6	18.0	13.2	7,300	166	64.6
Luxembourg	64.6	72.1	56.9	59.3	70.7	47.9	4.9	3.9	6.3	65,099	110	170.9
Hungary	55.8	61.2	50.6	54.7	60.7	48.9	11.0	11.0	11.0	9,000	122	72.1
Malta	57.6	73.6	41.0	55.0	72.8	36.8	6.5	6.2	7.1	13,300	116	92.1
Netherlands	74.9	79.8	69.9	57.3	70.7	44.7	4.4	4.5	4.4	33,300	109	111.5
Austria	72.1	77.8	66.5	63.7	75.4	52.6	4.2	4.1	4.4	32,000	113	116.2
Poland	59.7	66.3	53.1	58.8	66.4	51.4	9.8	9.1	10.5	8,100 ³⁾	145 ³⁾	68.9
Portugal	64.2	68.1	60.4	61.1	66.1	56.2	13.4	13.2	13.5	14,600	99	75.3
Romania	58.5	65.0	52.0	56.9	63.9	50.0	7.7	8.2	7.1	4,200 ³⁾	145 ³⁾	51.1
Slovenia	64.4	67.7	60.9	62.0	66.1	57.6	8.3	8.3	8.3	15,400	124	81.8
Slovakia	59.5	66.3	52.7	58.0	65.3	50.7	13.6	13.6	13.6	9,200	159	80.3
Finland	69.0	70.6	67.4	64.9	67.8	62.1	7.9	8.6	7.2	31,300	115	109.5
Sweden	74.1	76.3	71.8	68.0	73.2	62.8	7.7	7.7	7.6	35,600	120	115.2
United Kingdom	69.5	74.5	64.5	60.0	70.0	50.8	8.2	8.8	7.4	30,500	110	104.0
EU-27	64.3	70.1	58.5	58.6	67.7	49.9	9.7	9.7	9.8	23,400	110	100.0

S: Eurostat. – Indicators according to gender are only entered as "total" in the calculation of the area index. 1) Compared to the previous year 2) GDP per capita in PPS, in comparison to EU-27 (EU-27=100), 3) 2010 values.

Table 30: Ranking position of area index 1 – Overall Labour Market Performance, EU-27
Ranking of the individual indicators, the sub-areas and the overall ranking

Rank	Employment			Unemployment Unemployment rate (15-64 years old)	Economic growth and productivity			Sub-area	Overall ranking
	Employment rate (15-64 years old)	Employment rate in full-time equivalents	Employment growth		Real GDP per capita (€ per inhabitant)	Real GDP per capita (index 2001 = 100)	Labour productivity per person employed		
1	NL	SE	EE	AT	LU	LT	LU	LU	LU
2	SE	CY	LU	NL	DK	LV	IE	IE	SE
3	DK	FI	MT	LU	IE	SK	BE	SE	AT
4	DE	DK	SE	DE	SE	BG	AT	BE	DE
5	AT	CZ	LT	MT	NL	EE	FR	AT	DK
6	UK	AT	SK	CZ	AT	RO	SE	FI	FI
7	FI	EE	BE ¹⁾	BE	FI	PL	NL	NL	NL
8	CY	DE	AT ¹⁾	DK ²⁾	UK	CZ	DK	DK	EE
9	CZ	SI	DE	RO ²⁾	DE	SI	IT	DE	UK
10	EE	PT	FI	SE ²⁾	BE	HU	FI	UK	CZ
11	LU	LV	PL	CY ¹⁾	FR	SE	ES	SK	CY
12	SI	UK	NL	FI ¹⁾	IT	MT	DE	FR	BE
13	PT	LT	FR ²⁾	UK	ES	FI	UK	LT	FR
14	FR	FR	CY ²⁾	SI	CY	AT	GR	LV	SI
15	BE	LU	UK ²⁾	IT	GR	DE	MT	ES	SK
16	LV	PL	RO	FR	SI	LU	CY	IT	LT
17	LT	SK	IT ¹⁾	PL	PT	UK	SI	EE	PL
18	PL	BG	HU ¹⁾	HU	MT	NL	SK	PL	MT
19	SK	NL	CZ	BG	CZ	BE	PT	SI	IE
20	IE	RO	DK	EE	SK	GR	CZ	CZ	RO
21	BG ¹⁾	BE	PT	PT	EE	IE	HU	MT	IT
22	RO ¹⁾	MT	SI	SK	HU	ES	PL	GR	PT
23	ES	HU	ES	IE	PL	FR	EE	CY	HU
24	MT	GR	IE	LV ¹⁾	LT	CY	LT	BG	LV
25	IT	ES	BG	LT ¹⁾	LV	DK	LV	RO	BG
26	HU	IT	GR	GR	RO	PT	RO	HU	ES
27	GR	IE	LV	ES	BG	IT	BG	PT	GR

S: Eurostat, WIFO calculations. – ¹⁾ As two consecutive countries have the same score (e.g. BG, RO) they occupy the same ranking. ²⁾ As three consecutive countries have the same score (e.g. FR, CY, UK) they occupy the same ranking.

- 89 -
 Table 31: Raw data of the individual indicators of area index 2 – Orientation towards Integration, EU-27

	Employment													
	Employment rate (25-44 years old)		Employment rate (55-64 years old)		Part-time employment, main reason: 1)		Temporary employment (main reason: could not find a permanent job)		Employment gender gap (15-64 years old) ²⁾					
	in %	in percentage points	in %	in %	Men	Women	in %	in %	Men	Women	in %	in %	in %	in percentage points
		Total	Men	Women	Total	Men	Women	Total	Men	Women	Total	Men	Women	
Belgium	80.6	9.4	38.7	46.0	31.6	10.4	75.9	76.0	75.8	10.4	75.9	76.0	75.8	10.4
Bulgaria	73.5	4.4	43.9	49.9	38.8	57.6	70.6	74.3	66.3	4.7	70.6	74.3	66.3	4.7
Czech Republic	81.1	21.5	47.6	58.9	37.2	18.5	79.9	82.6	77.6	16.8	79.9	82.6	77.6	16.8
Denmark	81.8	7.8	59.5	63.8	55.3	16.1	45.7	39.7	51.2	5.5	45.7	39.7	51.2	5.5
Germany	82.3	10.6	59.9	67.0	53.0	17.0	24.7	22.5	27.1	9.6	24.7	22.5	27.1	9.6
Estonia	77.7	11.2	57.2	57.3	57.1	22.0	36.2	43.1	:	4.9	36.2	43.1	:	4.9
Ireland	69.8	8.0	50.0	57.2	42.9	37.7	67.9	71.6	64.6	7.7	67.9	71.6	64.6	7.7
Greece	69.6	20.4	39.4	52.3	27.3	60.5	86.1	86.8	85.4	20.8	86.1	86.8	85.4	20.8
Spain	69.2	9.6	44.5	53.9	35.6	55.5	91.5	91.4	91.6	11.2	91.5	91.4	91.6	11.2
France	80.8	11.3	41.4	44.0	39.0	30.8	57.3	53.0	61.2	8.4	57.3	53.0	61.2	8.4
Italy	70.5	22.7	37.9	48.4	28.1	54.5	70.5	67.8	73.4	21.0	70.5	67.8	73.4	21.0
Cyprus	82.7	6.6	55.2	69.8	41.1	49.6	94.5	90.7	95.9	13.1	94.5	90.7	95.9	13.1
Latvia	76.1	3.3	51.1	52.6	49.9	42.1	71.4	68.8	75.0	2.1	71.4	68.8	75.0	2.1
Lithuania	77.8	-2.5	50.5	54.5	47.4	37.5	62.8	63.7	61.1	0.4	62.8	63.7	61.1	0.4
Luxembourg	83.6	15.2	39.3	47.0	31.3	9.9	45.2	38.7	51.8	15.2	45.2	38.7	51.8	15.2
Hungary	73.0	17.1	35.8	39.8	32.4	39.4	65.4	67.0	63.6	10.6	65.4	67.0	63.6	10.6
Malta	75.9	29.7	31.7	50.1	13.8	16.1	50.7	47.2	54.8	32.6	50.7	47.2	54.8	32.6
Netherlands	85.1	9.0	56.1	65.8	46.4	7.2	32.3	32.4	32.2	9.9	32.3	32.4	32.2	9.9
Austria	85.4	9.8	41.5	50.6	32.9	10.1	8.5	7.3	9.8	11.3	8.5	7.3	9.8	11.3
Poland	78.9	14.0	36.9	47.8	27.3	24.8	61.6	61.8	61.4	13.2	61.6	61.8	61.4	13.2
Portugal	79.5	5.7	47.9	54.2	42.1	45.8	85.7	84.9	86.6	7.7	85.7	84.9	86.6	7.7
Romania	75.5	12.5	40.0	48.9	32.2	53.0	80.1	81.6	77.7	13.0	80.1	81.6	77.7	13.0
Slovenia	84.4	3.1	31.2	39.5	22.7	8.0	56.6	56.6	56.6	6.8	56.6	56.6	56.6	6.8
Slovakia	75.0	16.6	41.4	52.6	31.5	24.4	84.3	87.8	80.8	13.6	84.3	87.8	80.8	13.6
Finland	81.2	8.5	57.0	56.8	57.2	28.8	64.2	61.4	66.0	3.2	64.2	61.4	66.0	3.2
Sweden	85.3	6.7	72.3	75.7	68.9	27.5	56.4	52.9	59.2	4.5	56.4	52.9	59.2	4.5
United Kingdom	79.7	13.6	56.7	64.2	49.6	18.8	59.4	64.7	53.9	10.0	59.4	64.7	53.9	10.0
EU-27	77.5	12.9	47.4	55.2	40.2	26.1	60.4	59.1	61.8	11.6	60.4	59.1	61.8	11.6

S: Eurostat. – Indicators according to gender are only entered as "total" in the calculation of the area index. 1) Could not find a full-time job. 2) Employment gender gap: difference between male and female employment rates. Note: Explanation of sign (:) represents values not available. Values with negative signs are entered into the calculation of the index as an amount (absolute value). The absolute amount can be obtained by leaving out the sign.



Continued: Raw data of the individual indicators of area index 2 – Orientation towards Integration, EU-27 (excl. LU and MT)

	Unemployment										Public expenditure on (active) labour market policies as a percentage of GDP ¹⁾		
	Unemployment rate (15-24 years old)		Unemployment rate (55-64 years old)		Long-term unemployment rate (15-64 years old)		Long-term unemployment rate (55-64 years old)		Unemployment rate		Expenditure for (active) LMP ²⁾	Expenditure for (active) LMP ²⁾	Participants in LMP measures ³⁾
	in %	in %	in %	in %	in %	in %	in %	in %	Men	Women	in % of GDP	in % of GDP	in %
		Total	Men	Women	Total	Men	Women	Total	Men	Women			
Belgium	18.7	48.4	47.1	49.8	75.6	74.3	77.3	1.27	0.15	11.9			
Bulgaria	26.6	56.1	57.1	54.8	61.9	61.3	62.7	0.09	0.01	0.8			
Czech Republic	18.0	40.6	40.5	40.6	45.0	45.2	44.6	0.23	0.03	1.1			
Denmark	14.2	24.4	26.3	22.3	42.9	43.3	42.3	1.41	0.19	6.7			
Germany	8.6	48.0	49.3	46.2	63.9	64.6	62.9	0.56	0.08	3.7			
Estonia	22.3	56.8	59.8	53.4	66.6	:	:	0.14	0.01	0.9			
Ireland	29.4	59.4	65.4	47.2	66.6	70.7	54.7	0.75	0.05	5.0			
Greece	44.4	49.6	45.0	54.0	55.3	52.8	60.2	0.22	0.02	1.9			
Spain	46.4	41.6	40.6	42.7	59.8	58.0	62.5	0.67	0.03	13.0			
France	22.1	41.4	42.2	40.7	59.6	58.1	61.2	0.83	0.09	5.8			
Italy	29.1	51.9	51.4	52.4	55.5	57.9	48.9	0.35	0.04	5.2			
Cyprus	22.4	20.9	21.7	20.0	31.8	33.6	:	0.25	0.04	2.0			
Latvia	29.1	54.6	59.0	48.5	67.1	68.5	65.7	0.51	0.03	2.7			
Lithuania	32.9	51.9	52.3	51.5	60.4	51.3	72.1	0.23	0.01	1.1			
Luxembourg	16.8	28.6	33.1	25.0	:	:	:	0.41	0.09	7.6			
Hungary	26.1	47.9	47.5	48.3	59.5	58.8	60.4	0.52	0.05	4.0			
Malta	13.7	46.2	53.3	34.7	:	:	:	0.04	0.01	1.1			
Netherlands	7.6	33.5	35.2	31.5	61.4	63.3	58.7	0.78	0.17	4.6			
Austria	8.3	25.9	27.6	24.2	56.2	58.5	:	0.66	0.15	4.0			
Poland	25.8	37.2	36.3	38.2	47.5	47.3	48.0	0.60	0.06	4.0			
Portugal	30.1	48.1	47.8	48.3	69.3	67.9	71.3	0.58	0.05	3.8			
Romania	23.7	41.9	42.6	41.0	47.2	46.1	:	0.03	0.00	0.5			
Slovenia	15.7	44.2	45.1	43.1	46.2	44.2	:	0.34	0.05	2.1			
Slovakia	33.2	67.8	69.1	66.2	76.6	74.5	80.4	0.23	0.02	3.8			
Finland	20.1	22.2	26.2	17.0	43.8	46.0	40.7	0.86	0.10	4.1			
Sweden	22.9	18.6	20.7	16.4	35.7	37.3	33.4	0.81	0.09	3.8			
United Kingdom	21.1	33.4	37.7	27.5	42.8	46.4	34.3	0.04 ⁴⁾	0.01 ⁴⁾	0.2 ⁴⁾			
EU-27	21.3	42.9	43.5	42.2	57.2	56.8	57.8	0.54 ⁴⁾	0.06 ⁴⁾	4.5 ⁴⁾			

S: Eurostat. – Indicators according to gender are only entered as “total” in the calculation of the area index. ¹⁾ 2010 values. ²⁾ Expenditure here includes the interventions 2-7. ³⁾ In % of the labour force. ⁴⁾ 2009 values. Note: Explanation of sign (:) represents values not available.

- 91 -

Table 32: Ranking positioning of area index 2 - Orientation towards Integration, EU-27 (excl. LU and MT)
Ranking of the individual indicators, the sub-areas and the overall ranking

Rank	Employment					Sub-area
	Employment rate (25-44 years old)	Employment gender gap (25-44 years old)	Employment rate (55-64 years old)	Part-time employment (main reason: could not find a full-time job)	Temporary employment (main reason: could not find a permanent job)	
1	AT	LT	SE	NL	AT	LT
2	SE	SI	DE	SI	DE	LV
3	NL	LV	DK	AT	NL	FI
4	SI	BG	EE	BE	EE	SE
5	CY	PT	FI	DK	DK	BG
6	DE	CY	UK	DE	SE	EE
7	DK	SE	NL	CZ	SI	DK
8	FI	DK	CY	UK	FR	SI
9	CZ	IE	LV	EE	UK	PT
10	FR	FI	LT	SK	PL	IE
11	BE	NL	IE	PL	LT	FR
12	UK	BE	PT	SE	FI	DE
13	PT	ES	CZ	FI	HU	NL
14	PL	AT	ES	FR	IE	UK
15	LT	DE	BG	LT	IT	BE
16	EE	EE	AT	IE	BG	HU
17	LV	FR	FR ¹⁾	HU	LV	ES
18	RO	RO	SK ¹⁾	LV	BE	AT
19	SK	UK	RO	PT	CZ	RO
20	BG	PL	GR	CY	RO	CY
21	HU	SK	BE	RO	SK	PL
22	IT	HU	IT	IT	PT	SK
23	IE	GR	PL	ES	GR	CZ
24	GR	CZ	HU	BG	ES	GR
25	ES	IT	SI	GR	CY	IT

S: Eurostat, WIFO calculations. – ¹⁾ As two consecutive countries have the same score (e.g. FR, SK) they occupy the same ranking.



Continued: Rank positioning of area index 2 - Orientation towards Integration, EU-27 (excl. LU and MT)
Ranking of the individual indicators, the sub-areas and the overall ranking

Rank	Unemployment				Public expenditure on labour market policy			Overall ranking		
	Unemployment rate (15-24 years old)	Unemployment rate (55-64 years old)	Long-term unemployment rate (15-64 years old)	Long-term unemployment rate (55-64 years old)	Sub-area	Expenditure on (active) LMP in % of GDP	Expenditure on (active) LMP in % of GDP per unemployed person		Participants in active LMP measures as a percentage of the labour force	Sub-area
1	NL	AT	SE	CY	CY	DK	DK	ES	BE	DK
2	AT	RO	CY	SE	SE	BE	NL	BE	DK	DK
3	DE	IT	FI	UK	AT	FI	BE	DK	NL	NL
4	DK	BE	DK	DK	DK	FR	AT	FR	ES	AT
5	SI	NL	AT	FI	FI	SE	FI	IT	AT	FI
6	CZ	SE	UK	CZ	NL	NL	SE	IE	FR	BE
7	BE	CY	NL	SI	UK	IE	FR	NL	FI	DE
8	FI	UK	PL	RO	CZ	ES	DE	FI	SE	SI
9	UK	DK	CZ	PL	RO	AT	PL	PL	IE	FR
10	FR	CZ	FR	GR	SI	PL	IE	AT	DE	CY
11	EE	SI	ES	IT	PL	PT	PT	HU	PL	UK
12	CY	FI	RO	AT	DE	DE	HU	SK	PT	PL
13	SE	DE	SI	HU	FR	HU	SI	PT	HU	EE
14	RO	FR	HU	FR	IT	LV	IT	SE	IT	CZ
15	PL	PL	DE	ES	BE	IT	CY	DE	LV	LT
16	HU	GR	PT	LT	HU	SI	ES	LV	SI	PT
17	BG	HU	BE	NL	BG	CZ	CZ	SI	SK	IE
18	IT ¹⁾	BG	GR	BG	GR	LV	LV	CY	CY	LV
19	LV ¹⁾	IE	IT ¹⁾	DE	EE	LT	GR	GR	CZ	HU
20	IE	SK	LT ¹⁾	EE ¹⁾	PT	CZ	SK	LT	GR	RO
21	PT	PT	LV	IE ¹⁾	IE	GR	LT	CZ	LT	BG
22	LT	EE	BG	LV	LT	EE	BG	EE	EE	ES
23	SK	LT	EE	PT	LV	BG	EE	BG	BG	IT
24	GR	LV	IE	BE	ES	UK	UK	RO	RO	SK
25	ES	ES	SK	SK	SK	RO	RO	UK	UK	GR

s: Eurostat, WIFO calculations. - 1) As two consecutive countries have the same score (e.g. IT, LV) they occupy the same ranking.



Table 33: Raw data of individual indicators of the area index 3 - Equity of Access and Continuity, EU-27 (excl. BG and EE)

	Early leavers from education and training	Population (25-64 years old) with low educational attainment (max. secondary level)	Population (25-34 years old), with low educational attainment (max. secondary level)	Population (25-64 years old), with tertiary educational attainment	Population (25-34 years old), with tertiary educational attainment	Life-long learning (Adult participation (25-64 years) in education and training)	Percentage of employees participating in continuing vocational training ¹⁾
	in %	in %	in %	in %	in %	in %	in %
Belgium	12.3	28.7	18.1	34.6	42.5	7.1	40.0
Bulgaria	12.8	19.8	17.7	23.4	27.0	1.2	15.0
Czech Republic	4.9	7.7	5.7	18.2	25.1	11.4	59.0
Denmark	9.6	23.1	19.7	33.7	38.6	32.3	35.0
Germany	11.5	13.7	13.2	27.6	27.7	7.8	30.0
Estonia	10.9	11.1	14.2	36.8	39.1	12.0	24.0
Ireland	10.6	26.6	15.0	37.7	47.2	6.8	49.0
Greece	13.1	35.5	23.3	25.4	32.0	2.4	14.0
Spain	26.5	46.2	35.5	31.6	39.2	10.8	33.0
France	12.0	28.4	16.7	29.8	43.0	5.5	46.0
Italy	18.2	44.0	28.7	14.9	21.0	5.7	29.0
Cyprus	11.2	25.0	15.4	37.4	50.4	7.5	30.0
Latvia	11.8	12.3	17.8	27.7	34.5	5.0	15.0
Lithuania	7.9	7.1	10.5	34.0	48.1	5.9	15.0
Luxembourg	6.2	22.7	16.6	37.0	46.6	13.6	49.0
Hungary	11.2	18.2	12.7	21.1	28.1	2.7	16.0
Malta	33.5	68.5	53.0	15.3	24.8	6.6	32.0
Netherlands	9.1	27.7	18.2	32.1	39.9	16.7	34.0
Austria	8.3	17.5	11.8	19.3	21.2	13.4	33.0
Poland	5.6	10.9	5.9	23.7	39.2	4.5	21.0
Portugal	23.2	65.0	44.3	17.3	26.9	11.0	28.0
Romania	17.5	25.1	23.9	14.9	22.6	1.6	17.0
Slovenia	4.2	15.5	6.0	25.1	33.8	15.9	50.0
Slovakia	5.0	8.7	5.9	18.8	25.7	3.9	38.0
Finland	9.8	16.3	9.8	39.3	39.4	23.8	39.0
Sweden	6.6	18.0	12.7	35.2	43.0	25.0	46.0
United Kingdom	15.0	23.6	17.2	37.0	43.8	15.8	33.0
EU-27	13.5	26.6	19.0	26.8	34.2	8.9	33.0

S: Eurostat. – Indicators according to gender are only entered as “total” in the calculation of the area index. ¹⁾ Continuing vocational training: CVTS (Continuing Vocational Training Survey) surveys are carried out every five years. Current values: 2005

Continued: Raw data of individual indicators of the area index 3 - Equity of Access and Continuity, EU-27 (excl. BG and EE)

	Exclusion										Childcare ¹⁾			
	Inactive population (Out of labour force), main reason: care responsibilities					Part-time employment, main reason: care responsibilities					Inactive population (Out of labour force)		Formal child care ³⁾ 1-29 hours weekly	Formal child care ³⁾ 30 hours and more weekly
	in %	in %	in %	in %	in %	in %	in %	in %	in %	in %	in %	in %	in %	
	Total	Men	Women	Total	Men	Women	Total	Men	Women	Total	Men	Women		
Belgium	3.6	0.4 ²⁾	6.0	16.2	4.6	19.1	33.3	27.7	38.9	17.0	19.0			
Bulgaria	6.2	0.9	10.4	:	:	:	34.0	30.4	37.6	1.0	6.0			
Czech Republic	15.6	0.4	24.4	16.2	1.3 ¹⁾	21.3	29.5	21.3	37.8	2.0	0.0			
Denmark	1.5	:	2.7	2.9	:	3.9	20.7	17.7	23.9	10.0	68.0			
Germany	8.3	0.7	13.1	22.8	3.2	26.9	22.8	17.5	28.2	7.0	13.0			
Estonia	14.1	:	23.3	:	:	:	25.3	21.9	28.5	2.0	19.0			
Ireland	13.1	:	24.3	15.0	:	19.9	30.6	23.2	37.9	21.0	8.0			
Greece	5.0	:	7.5	5.8	:	9.1	32.3	22.3	42.5	3.0	5.0			
Spain	8.2	0.7	12.5	13.8	2.7	17.3	26.3	19.6	33.0	20.0	18.0			
France	1.8	0.4 ¹⁾	3.6	29.1	6.9	33.8	29.6	25.3	33.9	17.0	26.0			
Italy	10.3	0.5	15.7	20.1	1.2	25.2	37.8	26.9	48.5	6.0	16.0			
Cyprus	9.5	:	14.6	10.4	:	16.2	26.0	18.7	33.2	11.0	13.0			
Latvia	6.8	:	11.3	4.5 ²⁾	:	7.4 ²⁾	26.7	23.5	29.8	1.0	15.0			
Lithuania	5.3	:	9.1	5.1 ²⁾	:	7.9 ²⁾	28.0	25.7	30.3	2.0	11.0			
Luxembourg	6.6	:	10.4	26.5	:	28.9	32.1	25.0	39.3	17.0	19.0			
Hungary	12.0	1.4	19.4	7.2	:	10.5	37.3	31.2	43.2	1.0	8.0			
Malta	8.2	:	11.1	16.1	:	21.4	38.4	21.5	55.9	7.0	4.0			
Netherlands	9.2	0.9 ²⁾	14.5	30.8	7.8	38.3	21.6	16.5	26.9	44.0	6.0			
Austria	8.9	:	14.1	33.0	3.6	39.1	24.7	18.9	30.5	6.0	3.0			
Poland	9.6	0.9	15.2	7.0	:	10.5	33.9	27.0	40.6	0.0	2.0			
Portugal	5.2	:	8.5	5.0	:	7.3	25.9	21.5	30.2	5.0	32.0			
Romania	2.2	:	3.5	2.6	:	4.9	36.7	29.3	44.0	4.0	3.0			
Slovenia	1.7	:	2.8	8.0	:	12.1	29.7	26.1	33.5	4.0	33.0			
Slovakia	15.2	1.4	23.4	3.5	:	5.2	31.1	23.3	39.0	0.0	3.0			
Finland	9.1	0.6 ²⁾	16.3	9.8	2.2	13.9	25.1	22.8	27.3	8.0	20.0			
Sweden	4.2	:	7.2	17.9	7.5	21.2	19.8	17.3	22.3	18.0	33.0			
United Kingdom	20.6	5.2	29.9	33.3	5.9	41.6	24.3	18.3	30.3	31.0	4.0			
EU-27	9.5	1.1	14.8	23.1	3.9	28.7	28.8	22.4	35.1	14.0	14.0			

S: Eurostat. – Indicators according to gender are only entered as "total" in the calculation of the area index. ¹⁾ 2010 values. ²⁾ 2009 values. ³⁾ Children less than three years. Note: Explanation of sign (-) represents values not available.

Continued: Raw data of individual indicators of the area index 3 - Equity of Access and Continuity, EU-27 (excl. BG and EE)

		Health ¹⁾													
	Number of fatal work-related accidents ²⁾	Healthy life years at birth – women		Healthy life years at birth – men		Healthy life years at the age of 65 – women		Healthy life years at the age of 65 – men		Employed persons with disabilities		Self-perceived limitations of employed persons ³⁾		Self-perceived health of employed persons ⁴⁾	
		year	year	year	year	year	year	year	year	in %	in %	in %	in %	in %	in %
	absolute	year	year	year	year	year	year	year	year	Total	Men	Women	in %	in %	
Belgium	65	62.7	64.1	9.7	10.4	14.5	13.4	15.8	10.4	14.5	13.4	15.8	10.4	85.7	
Bulgaria	78	67.2	63.0	9.9	8.8	7.8	6.6	9.4	5.1	7.8	6.6	9.4	5.1	85.9	
Czech Republic	91	64.6	62.2	8.8	8.5	16.0	15.7	16.2	10.1	16.0	15.7	16.2	10.1	79.7	
Denmark	31	61.9	62.3	12.8	11.8	18.7	17.3	20.4	17.8	18.7	17.3	20.4	17.8	80.1	
Germany	454	58.6	57.9	7.1	6.9	23.9	23.1	24.9	18.8	23.9	23.1	24.9	18.8	78.3	
Estonia	13	58.1	54.0	5.5	5.3	31.3	29.9	32.5	16.7	31.3	29.9	32.5	16.7	66.4	
Ireland	81	66.9	65.9	11.2	11.1	16.2	14.7	18.0	7.1	16.2	14.7	18.0	7.1	92.3	
Greece	63	67.6	66.4	8.1	8.8	8.0	8.5	7.3	5.3	8.0	8.5	7.3	5.3	91.5	
Spain	354	63.7	64.3	8.9	9.6	17.8	17.5	18.2	10.7	17.8	17.5	18.2	10.7	86.2	
France	492	63.5	61.9	9.8	9.0	25.9	24.6	27.3	14.2	25.9	24.6	27.3	14.2	78.5	
Italy	633	67.3	67.3	9.9	10.1	12.8	12.1	13.9	8.6	12.8	12.1	13.9	8.6	82.9	
Cyprus	7	64.9	65.1	8.2	10.0	23.8	25.8	21.2	10.2	23.8	25.8	21.2	10.2	85.8	
Latvia	29	56.5	53.5	5.6	4.9	20.3	18.2	22.1	16.3	20.3	18.2	22.1	16.3	61.1	
Lithuania	45	62.3	57.7	6.7	6.3	12.3	10.9	13.6	7.7	12.3	10.9	13.6	7.7	65.9	
Luxembourg	5	66.0	64.5	12.4	10.5	15.3	15.7	14.7	13.5	15.3	15.7	14.7	13.5	84.0	
Hungary	91	58.6	56.4	5.9	5.4	19.6	18.3	21.2	12.4	19.6	18.3	21.2	12.4	72.3	
Malta	6	71.6	70.2	11.9	12.0	13.8	14.9	11.6	3.9	13.8	14.9	11.6	3.9	84.0	
Netherlands	54	60.2	61.1	9.5	9.4	22.8	21.0	24.9	15.9	22.8	21.0	24.9	15.9	87.9	
Austria	153	60.7	59.3	7.9	8.5	23.7	23.1	24.5	16.5	23.7	23.1	24.5	16.5	83.4	
Poland	334	62.2	58.5	7.5	6.7	18.5	17.4	19.6	10.2	18.5	17.4	19.6	10.2	74.8	
Portugal	204	56.6	59.2	5.7	7.1	18.0	15.1	21.3	14.8	18.0	15.1	21.3	14.8	65.0	
Romania	370	57.4	57.4	5.0	5.9	5.8	5.2	6.6	11.0	5.8	5.2	6.6	11.0	88.6	
Slovenia	26	54.5	53.2	7.2	6.6	23.5	22.6	24.5	24.3	23.5	22.6	24.5	24.3	72.2	
Slovakia	42	52.1	52.3	2.8	3.3	18.6	16.9	20.7	21.0	18.6	16.9	20.7	21.0	77.1	
Finland	28	57.8	58.5	8.9	8.8	32.3	25.8	39.4	20.5	32.3	25.8	39.4	20.5	83.2	
Sweden	37	71.0	71.7	15.5	14.1	24.3	22.1	26.8	8.6	24.3	22.1	26.8	8.6	88.3	
United Kingdom	133	65.7	65.1	11.8	10.9	22.4	21.3	23.6	9.6	22.4	21.3	23.6	9.6	90.0	
EU-27	3,856	62.6	61.7	8.8	8.7	19.6	18.4	21.1	12.6	19.6	18.4	21.1	12.6	82.2	

S: Eurostat. – Indicators according to gender are only entered as "total" in the calculation of the area index. ¹⁾ 2010 values (except work-related accidents) ²⁾ 2009 values, except GR (2007) ³⁾ The expressions "severe" and "some limited" were combined. ⁴⁾ The expressions "good" and "very good" were combined.



Table 34: Ranking position of the area index 3 – Equity of Access and Continuity, EU-27 (excl. BG and EE)
Ranking of the individual indicators, the sub-areas and the overall ranking

Rank	Education					Sub-area	Exclusion			Sub-area
	Early leavers from education and training	Population (25-64 years old) with low educational attainment (max. sec. level I)	Population (25-64 years old) with low educational attainment (max. sec. level II)	Population (25-64 years old) with tertiary educational attainment	Life-long learning (Adult participation (25-64 years) in education and training)		Percentage of employees of employees participating in continuing vocational training	Inactive population (Out of labour force), main reason: care responsibilities	Part-time employment, main reason: care responsibilities	
1	SI	LT	CZ	FI	DK	SE	DK	RO	SE	DK
2	CZ	CZ	PL ¹⁾	IE	SE	FI	SI	DK	DK	SE
3	SK	SK	SK ¹⁾	CY	FI	LU	IE ¹⁾	SK	NL	PT
4	PL	PL	SI	LU ¹⁾	NL	DK	LU ¹⁾	LV	DE	SI
5	LU	LV	FI	UK ¹⁾	SI	SI	FR ^{1a)}	PT	UK	LT
6	SE	DE	LT	SE	UK	IE	SE ^{1a)}	LT	AT	LV
7	LT	SI	AT	BE	LU	CZ	BE	GR	FI	RO
8	AT	FI	HU ¹⁾	LT	AT	CY	FI	PL	PT	FI
9	NL	AT	SE ¹⁾	DK	CZ	UK	SK	HU	CY	GR
10	DK	SE	DE	NL	PT	LT	DK	SI	ES	CY
11	FI	HU	IE	ES	ES	NL	NL	FI	LV	ES
12	IE	LU	CY	FR	DE	BE	ES ²⁾	CY	LT	DE
13	CY ¹⁾	DK	LU	LV	CY	FR	AT ²⁾	ES	CZ	BE
14	HU ¹⁾	UK	FR	DE	BE	PL	UK ²⁾	IE	FR	FR
15	DE	CY	UK	GR	IE	SK	MT	MT	SI	PL
16	LV	RO	LV	SI	MT	DE	DE ¹⁾	BE ¹⁾	IE	NL
17	FR	IE	BE	PL	LT	AT	CY ¹⁾	CZ ¹⁾	SK	SK
18	BE	NL	NL	HU	IT	LV	IT	SE	LU	AT
19	GR	FR	DK	AT	FR	HU	PT	IT	GR	IE
20	UK	BE	GR	SK	LV	ES	PL	DE	BE	LU
21	RO	GR	RO	CZ	PL	GR	RO	LU	PL	HU
22	IT	IT	IT	PT	SK	RO	HU	FR	RO	CZ
23	PT	ES	ES	MT	HU	IT	LV ¹⁾	NL	HU	MT
24	ES	PT	PT	IT ¹⁾	GR	PT	LT ¹⁾	AT	IT	IT
25	MT	MT	MT	RO ¹⁾	RO	MT	GR	UK	MT	UK

S: Eurostat, WIFO calculations. –¹⁾ and ^{1a)} As two consecutive countries have the same score (e.g. CY, HU) they occupy the same ranking. ²⁾ As three consecutive countries have the same score (ES, AT, UK) they occupy the same ranking.



Continued: Ranking position of the area index 3 – Equity of Access and Continuity, EU 27 (excl. BG and EE)
Ranking of the individual indicators, the sub-areas and the overall ranking

Rank	Childcare		Health										Overall ranking	
	Formal child care (children less than three years) 1-29 hours weekly	Formal child care (children less than three years) 30 hours and more weekly	Number of fatal work-related accidents	Healthy life years at birth – women	Healthy life years at birth – men	Healthy life years at the age of 65 – women	Healthy life years at the age of 65 – men	Employed persons with disabilities	Self-perceived limitations of employed persons	Self-perceived health of employed persons	Sub-area			
	Sub-area	LU		MT	SE	SE	SE	SE	FI	SI		IE		SE
1	NL	DK	DK	MT	SE	SE	SE	SE	FI	SI	IE	SE	SE	SE
2	UK	SI ¹⁾	NL	SE	MT	DK	MT	MT	FR	SK	GR	GR	MT	DK
3	IE	SE ¹⁾	SE	GR	IT	LU	DK	LU	SE	FI	UK	UK	UK	FI
4	ES	PT	FR	IT	GR	MT	IE	MT	DE	DE	RO	RO	DK	LU
5	SE	FR	UK	IE	IE	UK	UK	UK	CY	DK	SE	SE	LU	NL
6	BE ²⁾	FI	ES	LU	CY ¹⁾	IE	LU	LU	AT	AT	NL	NL	IE	IE
7	FR ²⁾	BE ¹⁾	BE ¹⁾	UK	UK ¹⁾	IT	BE	BE	SI	LV	ES	ES	FI	CY
8	LU ²⁾	LU ¹⁾	LU ¹⁾	CY	LU	FR	FR	IT	NL	NL	CY	CY	CY	SI
9	CY	ES	PT	CZ	ES	BE	CY	CY	UK	PT	BE	BE	NL	UK
10	DK	IT	SI	ES	BE	NL	ES	ES	LV	FR	LU ¹⁾	LU ¹⁾	BE	BE
11	FI	LV	IE	FR	DK	ES ¹⁾	NL	NL	HU	LU	MT ¹⁾	MT ¹⁾	AT	FR
12	DE ¹⁾	DE ¹⁾	FI	BE	CZ	FI ¹⁾	FR	FR	DK	HU	AT	AT	GR	CZ
13	MT ¹⁾	CY ¹⁾	CY	LT	FR	CZ	GR ¹⁾	GR ¹⁾	SK	RO	FI	ES	ES	ES
14	IT ¹⁰⁾	IT	IT	PL	NL	CY	FI ¹⁾	FI ¹⁾	PL	ES	IT	IT	FR	AT
15	AT ¹⁰⁾	IE ¹⁾	DE	DK	AT	GR	CZ ¹⁰⁾	CZ ¹⁰⁾	PT	BE	DK	DK	CZ	LT
16	PT	HU ¹⁾	LV	AT	PT	AT	AT ¹⁰⁾	AT ¹⁰⁾	ES	PL	CZ	CZ	IT	DE
17	RO ¹⁾	NL	LT	NL	PL ¹⁾	PL	PL	PT	IE	CY	FR	FR	SI	GR
18	SI ¹⁾	GR	MT	DE ¹⁾	FI ¹⁾	SI	DE	DE	CZ	CZ	DE	DE	DE	PL
19	GR	MT ¹⁾	AT	HU ¹⁾	DE	DE	PL	PL	LU	UK	SK	SK	PL	LV
20	CZ ¹⁾	UK ¹⁾	HU	FI	LT	LT	SI	SI	BE	IT ¹⁾	PL	PL	HU	SK
21	LT ¹⁾	AT ²⁾	GR	RO	RO	HU	LT	LT	MT	SE ¹⁾	HU	HU	PT	MT
22	LV ¹⁰⁾	RO ²⁾	RO	PT	HU	PT	RO	RO	IT	LT	SI	SI	LT	HU
23	HU ¹⁰⁾	SK ²⁾	SK	LV	LV	LV	HU	HU	LT	IE	LT	LT	LV	IT
24	PL ¹⁾	PL	CZ	SI	SI	RO	RO	RO	GR	GR	PT	PT	SK	PT
25	SK ¹⁾	CZ	PL	SK	SK	SK	SK	SK	RO	MT	LV	LV	RO	RO

S: Eurostat, WIFO calculations. – 1) and 10) As two consecutive countries have the same score (e.g. DE, MT) they occupy the same ranking. 2) As three consecutive countries have the same score (e.g. BE, FR, LU) they occupy the same ranking.

- 98 -
Table 35: Raw data of the individual indicators of area index 4 – Distribution of Earnings, EU-27

	Income/salary		Distribution of earnings		Taxes on labour ¹⁾		Working poor		Proportion of low wage earners (full-time employees) ¹⁾		Gender pay gap	
	Nominal wages per employee in PPS	Compensation of employees	Inequality of income distribution		in % of total taxation	Working poor		Proportion of low wage earners (full-time employees) ¹⁾		Gender pay gap		
			in % of GDP	income quintile share ratio		Men	Women	Men	Women	in %	in %	Men
Belgium	32,445	44,292	3.9	3.9	54.1	4.3	4.0	4.2	4.3	4.0	5.4	8.6
Bulgaria	10,693	12,585	5.9 ¹⁾	5.7 ¹⁾	32.9	8.1	7.3	7.7	8.1	7.3	25.5	15.7
Czech Republic	16,522	21,747	3.5	3.5	52.3	4.1	4.0	4.0	4.1	4.0	17.1	25.5
Denmark	33,462	36,741	4.4	4.7	51.7	7.1	5.6	6.4	7.1	5.6	7.9	16.0
Germany	28,256	34,637	4.5	4.6	56.2	7.2	8.2	7.7	7.2	8.2	20.9	23.1
Estonia	14,394	19,318	5.3	5.7	53.9	6.8	9.0	7.9	6.8	9.0	23.2	27.6 ⁴⁾
Ireland	38,211	41,465	5.3 ¹⁾	5.5 ¹⁾	41.4	10.1 ¹⁾	4.7 ¹⁾	7.6 ¹⁾	10.1 ¹⁾	4.7 ¹⁾	20.4	12.6
Greece	20,992	27,232	5.6 ¹⁾	5.6 ¹⁾	39.9	16.4 ¹⁾	10.2 ¹⁾	13.8 ¹⁾	16.4 ¹⁾	10.2 ¹⁾	16.8 ³⁾	22.0 ⁴⁾
Spain	26,275 ¹⁾	33,798	6.8	6.8	52.2	13.8	10.4	12.3	13.8	10.4	16.4	16.7
France	28,150	38,387	4.5 ¹⁾	4.4 ¹⁾	54.3	6.5 ¹⁾	5.8 ¹⁾	6.2 ¹⁾	6.5 ¹⁾	5.8 ¹⁾	8.9	16.0
Italy	24,928	34,131	5.2 ¹⁾	5.2 ¹⁾	51.6	10.8 ¹⁾	7.3 ¹⁾	9.4 ¹⁾	10.8 ¹⁾	7.3 ¹⁾	10.9	5.5
Cyprus	24,413	28,348	4.4 ¹⁾	4.2 ¹⁾	35.5	5.8 ¹⁾	8.2 ¹⁾	6.9 ¹⁾	5.8 ¹⁾	8.2 ¹⁾	21.3	21.0
Latvia	13,882	16,539	6.6	7.2	52.5	8.3	10.3	9.3	8.3	10.3	28.0	17.6
Lithuania	12,778	16,193	5.8	6.0	49.5	10.0	10.1	10.1	10.0	10.1	26.5	14.6
Luxembourg	41,005	47,412	4.0	4.1	43.3	9.3	10.6	9.9	9.3	10.6	15.6	12.0
Hungary	16,129	19,923	3.9	4.0	48.3	6.7	5.4	6.1	6.7	5.4	21.8	17.6
Malta	23,738	26,287	4.1	4.0	32.2	7.7	2.9	6.0	7.7	2.9	14.1	6.1
Netherlands	29,081	37,339	3.8	3.8	55.0	5.9	5.0	5.5	5.9	5.0	14.9	18.5
Austria	30,199	37,350	3.8	3.8	56.8	6.0	4.6	5.4	6.0	4.6	15.2	25.5
Poland	15,797	18,146	5.0	5.1	36.3	12.3	9.7	11.1	12.3	9.7	22.0	5.3
Portugal	18,422 ²⁾	24,404	5.7	5.8	40.9	10.6	9.9	10.3	10.6	9.9	20.7	12.8
Romania	14,092	16,513	6.2	6.3	41.5	21.1	16.2	19.0	21.1	16.2	26.8	12.5
Slovenia	25,412	29,609	3.5	3.4	51.8	7.2	4.5	6.0	7.2	4.5	13.6	4.4
Slovakia	15,728	20,200	3.8 ¹⁾	4.0 ¹⁾	43.4	5.9 ¹⁾	5.4 ¹⁾	5.7 ¹⁾	5.9 ¹⁾	5.4 ¹⁾	18.1	20.7
Finland	29,101	35,826	3.7	3.8	53.4	4.3	6.8	3.9	4.3	3.4	7.0	19.4
Sweden	27,972	36,064	3.6	3.5	56.4	6.9	6.8	6.9	6.9	6.8	5.6	15.8
United Kingdom	30,557	36,956	5.4 ¹⁾	5.5 ¹⁾	40.2	6.8 ¹⁾	6.8 ¹⁾	6.8 ¹⁾	6.8 ¹⁾	6.8 ¹⁾	22.0	19.5
EU-27	25,988	32,959	5.3	5.4	51.2	8.4 ¹⁾	7.8 ¹⁾	8.4 ¹⁾	8.4 ¹⁾	7.8 ¹⁾	:	16.4

S: Eurostat. – Indicators according to gender are only entered as "total" in the calculation of the area index. ¹⁾ 2010 values. ²⁾ 2009 values. ³⁾ 2006-4) 2008 values. Note: Explanation of sign (:) represents values not available.



Table 36: Ranking position of area index 4 – Distribution of Earnings, EU-27
Ranking of the individual indicators, the sub-areas and the overall ranking

Rank	Income/salary		Distribution of earnings			Working poor		Working poor		Gender pay gap		Overall ranking
	Nominal wages per employee in PPS	Compensation of employees per capita in PPS	Sub-area	Compensation of employees as a percentage of GDP	Inequality of income distribution – income quintile share ratio	Taxes on labour as a percentage of total taxation	Sub-area	Working poor	Proportion of low wage earners (full-time employees)	Sub-area	Gender pay gap	
1	LU	LU	LU	DK	CZ ¹⁾	MT	MT	FI	BE	BE	SI	BE
2	IE	BE	IE	UK	SI ¹⁾	BG	CY	CZ	SE	FI	PL	LU
3	DK	IE	BE	FR	SE	CY	SI	BE	FI	SE	IT	DK
4	BE	FR	DK	SE	FI	PL	UK	AT	DK	DK	MT	SI
5	UK	AT	UK	SI	NL ²⁾	GR	LU	NL	FR	FR	BE	FI
6	AT	NL	AT	BE	AT ²⁾	UK	DK	SK	IT	CZ	LU	MT
7	FI	UK	NL	DE	SK ²⁾	PT	FI	MT ¹⁾	SI	SI	RO	SE
8	NL	DK	FR	NL ¹⁾	BE ¹⁾	IE	SE	SI ¹⁾	MT	NL	IE	FR
9	DE	SE	FI	FI ¹⁾	HU ¹⁾	RO	BE	HU	NL	AT	PT	NL
10	FR	FI	SE	PT	LU	LU	NL	FR	AT	MT	LT	IE
11	SE	DE	DE	AT	MT	SK	FR	DK	LU	SK	BG	UK
12	ES	IT	ES	ES	DK ¹⁾	HU	PT	UK	ES	IT	SE	AT
13	SI	ES	IT	LU	CY ¹⁾	LT	HU	CY ¹⁾	GR	HU	DK ¹⁾	IT
14	IT	SI	SI	EE	DE ¹⁰⁾	IT	AT	SE ¹⁾	CZ	CY	FR ¹⁾	CY
15	CY	CY	CY	CY	FR ¹⁰⁾	DK	SK	IE	SK	LU	ES	DE
16	MT	GR	MT	HU ¹⁾	PL	SI	CZ	BG ¹⁾	IE	IE	LV ¹⁾	PT
17	GR	MT	GR	MT ¹⁾	IT	ES	DE	DE ¹⁾	PT	UK	HU ¹⁾	HU
18	PT	PT	PT	IE	EE ¹⁾	CZ	IE	EE	DE	DE	NL	CZ
19	CZ	CZ	CZ	CZ ¹⁾	IE ¹⁾	LV	PL	LV	CY	EE	FI	SK
20	HU	SK	HU	IT ¹⁾	UK	FI	BG	IT	HU	BG	UK	PL
21	PL	HU	SK	LV	GR	EE	EE	LU	PL	ES	SK	ES
22	SK	EE	PL	LT	PT	BE	IT	LT	UK	PT	CY	GR
23	EE	PL	EE	RO	LT	FR	GR	PT	EE	PL	GR	BG
24	RO	LV	RO	SK	BG	NL	RO	PL	BG	GR	DE	EE
25	LV	RO	LV	BG	RO	DE	ES	ES	LT	LV	CZ ¹⁾	LT
26	LT	LT	LT	PL	LV	SE	LT	GR	RO	LT	AT ¹⁾	LV
27	BG	BG	BG	GR	ES	AT	LV	RO	LV	RO	EE	RO

S: Eurostat, WIFO Calculations. –¹⁾ and ¹⁰⁾ As two consecutive countries have the same score (e.g. NL, FI) they occupy the same ranking. ²⁾ As three consecutive countries have the same score (e.g. NL, AT, SK) they occupy the same ranking.



- 100 -
Table 37: Raw data of the individual indicators of area index 5 - Distribution by the Welfare State, EU-27

	Social protection benefits										At-risk-of-poverty		Expenditure on education	
	Social protection benefits according to function 1)					Other functions 4)					Improvement in the rate of at-risk-of-poverty through transfers	Relative median at-risk-of-poverty gap	Public expenditure on education 1)5)	
	Sickness/health care	Disability	Old age	Family/children	Unemployment 3)	in % of GDP	in % of GDP	in % of GDP	in % of GDP	in % of GDP			in percentage points	in %
Belgien	8.2	2.0	9.4	2.2	0.5	3.2	15.3	12.5	18.6	6.6				
Bulgarien	3.9	1.4	7.8	2.0	0.1	1.0	22.4	4.9	29.0	4.6				
Tschechische Republik	6.4	1.5	8.3	1.4	0.2	1.1	9.8	8.2	17.2	4.4				
Dänemark	7.6	4.9	12.1	4.2	0.4	1.6	13.0	15.4	21.4	8.7				
Deutschland	9.7	2.4	10.0	3.2	0.2	3.0	15.8	9.3	21.4	5.1				
Estland	5.4	1.9	7.9	2.3	0.1	0.3	17.5	7.4	26.0	6.1				
Irland	10.7	1.3	5.6	3.7	0.3	2.0	16.1 ²⁾	24.3 ²⁾	15.2 ²⁾	6.5				
Griechenland	8.0	1.3	11.3	1.8	0.2	3.3	21.4	3.4	26.1	4.1				
Spanien	7.3	1.7	7.7	1.5	0.2	2.6	21.8	8.0	30.8	5.0				
Frankreich	9.4	1.9	12.4	2.6	0.2	3.4	14.0	10.7	17.1	5.9				
Italien	7.3	1.7	14.4	1.4	0.1	2.7	18.2 ²⁾	5.1 ²⁾	24.5 ²⁾	4.7				
Zypern	5.1	0.7	7.9	2.2	0.2	3.7	15.8 ²⁾	7.5 ²⁾	18.0 ²⁾	8.0				
Lettland	3.9	1.3	7.5	1.7	0.1	0.6	19.3	8.0	31.7	5.6				
Litauen	5.4	2.1	8.4	2.8	0.1	1.1	20.0	11.8	28.7	5.6				
Luxemburg	5.8	2.6	6.2	4.0	0.2	2.9	13.6	13.6	15.7	3.2				
Ungarn	5.7	2.1	9.1	3.0	0.1	2.1	13.8	15.1	18.3	5.1				
Malta	6.1	0.9	8.5	1.3	0.1	2.4	15.4	7.5	17.7	5.5				
Niederlande	10.3	2.5	10.4	1.3	0.4	3.7	11.0	9.9	15.5	5.9				
Österreich	7.6	2.3	12.7	3.1	0.4	2.5	12.6	12.3	19.0	6.0				
Polen	4.7	1.4	9.8	0.8	0.0	2.2	17.7	6.4	21.4	5.1				
Portugal	7.3	2.2	11.2	1.5	0.1	2.2	18.0	7.4	23.2	5.8				
Rumänien	4.1	1.6	8.0	1.7	0.1	1.0	22.2	6.9	31.8	4.2				
Slowenien	7.8	1.7	9.2	2.1	0.1	2.3	13.6	10.6	19.9	5.7				
Slowakei	5.7	1.7	6.7	1.7	0.1	1.4	12.0 ²⁾	7.8 ²⁾	25.7 ²⁾	4.1				
Finnland	7.5	3.6	10.4	3.3	0.3	2.2	13.7	13.7	13.5	6.8				
Schweden	8.0	4.5	12.7	3.2	0.2	1.8	14.0	13.9	18.5	7.3				
Vereinigtes Königreich	8.7	3.0	12.0	1.8	0.1	1.8	17.1 ²⁾	13.9 ²⁾	21.4 ²⁾	5.7				

S: Eurostat. - 1) 2009 values. 2) 2010 values. 3) Expenditure on unemployment in % of GDP divided by the unemployment rate. 4) Other functions included here are: survivors, housing and social exclusion. 5) Total public expenditure on education, for all levels of education combined. GR 2005, LU 2007.



Table 38: Ranking position of the area index 5 - Distribution welfare state, EU-27
Ranking of the individual indicators, the sub-areas and the overall ranking

Rank	Social protection benefits										At-risk-of-poverty			Expenditure on educ. Total public expenditure on education in % of GDP	Overall ranking
	Social protection benefits according to function as a percentage of GDP					Sub-area					At-risk-of-poverty rate offer social transfers	Improve-ment in the at-risk-of-poverty rate through transfers	Relative median at-risk-of-poverty gap		
Sickness/health care	Disability	Old age	Family/children	Unemployment/unemployment rate	Other functions:	Sub-area	At-risk-of-poverty rate offer social transfers	Improve-ment in the at-risk-of-poverty rate through transfers	Relative median at-risk-of-poverty gap	Sub-area				At-risk-of-poverty	Total public expenditure on education in % of GDP
1	IE	DK	IT	DK	BE	CY	DK	BE	CY	DK	CZ	IE	DK	DK	DK
2	NL	SE	SE	LU	NL	NL	LU	NL	NL	NL	NL	FI	CY	CY	SE
3	DE	FI	AT	IE	AT	FR	IE	AT	FR	SE	SK	IE	SE	SE	FI
4	FR	UK	FR	FI	DK	GR	FR	DK	GR	AT	AT	LU	FI	FI	NL
5	UK	LU	DK	SE	FI	BE	DE	FI	BE	DE	DK	FR	BE	BE	AT
6	BE	NL	UK	DE	IE	DE	FR	IE	DE	FR	LU ¹⁾	CZ	IE	IE	IE
7	SE	DE	GR	AT	LU	LU	AT	LU	LU	FI	SI ¹⁾	MT	EE	EE	BE
8	GR	AT	PT	HU	DE	IT	HU	DE	IT	BE	FI	CY	AT	AT	FR
9	SI	PT	NL	LT	FR	ES	LU	FR	ES	LU	HU	HU	NL	NL	DE
10	AT	HU	FI	FR	ES	AT	UK	FR	AT	UK	FR ¹⁾	SE	FR	FR	LU
11	DK	LT	DE	EE	CY	MT	IE	CY	MT	IE	FR	BE	PT	PT	UK
12	FI	BE	PL	BE	GR	SI	GR	GR	SI	GR	BE	AT	SI	SI	HU
13	IT	EE	BE	CY	CZ	PL	IT	CZ	PL	IT	MT	SI	UK	UK	CY
14	ES	FR	SI	SI	SE	PT	PT	SE	PT	PT	DE	DK ²⁾	MT	LV ¹⁾	SI
15	PT	SI	HU	BG	PT	FI	SI	PT	FI	SI	DE	DK ²⁾	CY	LV ¹⁾	PT
16	CZ	IT	MT	GR	UK	HU	HU	UK	HU	HU	CZ	DE ²⁾	DE	MT	IT
17	MT	SK	LT	UK	IT	IE	ES	IT	IE	ES	IE	PL ²⁾	SK	HU	CZ
18	LU	ES	CZ	LV	SI	UK	CY	SI	UK	CY	UK	UK ²⁾	PL	MT	MT
19	SK	RO	RO	RO	HU	SE	LT	HU	SE	LT	EE	PT	PL	PL	GR
20	HU	CZ	EE	SK	LV	DK	CZ	LV	DK	CZ	PT	SK	ES	DE	LT
21	LT	PL	CY	ES	EE	SK	MT	EE	SK	MT	IT	EE	IT	ES	ES
22	EE	BG	BG	PT	SK	CZ	PL	SK	CZ	PL	LV	GR	BG	BG	SK
23	CY	IE	ES	CZ	MT	LT	SK	MT	LT	SK	LT	GR	CZ	CZ	EE
24	PL	GR	LV	IT	BG	BG	EE	BG	BG	EE	GR	PL	RO	RO	PL
25	RO	LV	SK	NL	LT	RO	BG	LT	RO	BG	ES	ES	GR	GR ¹⁾	LV
26	BG	MT	LU	MT	RO	LV	RO	RO	LV	RO	RO	LV	SK ¹⁾	SK ¹⁾	BG
27	LV	CY	IE	PL	PL	EE	LV	PL	EE	LV	BG	RO	LU	LU	RO

S: Eurostat, WIFO calculations. - ¹⁾ As two consecutive countries have the same score (e.g. LU, SI) they occupy the same ranking. ²⁾ As four consecutive countries have the same score (e.g. DK, DE, PL, UK) they occupy the same ranking.

